

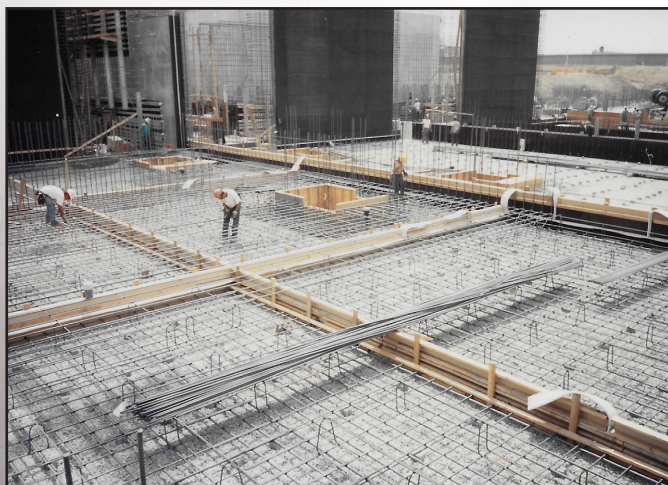

# EARTH SHIELD®



## CRD C572-74 Certified PVC Waterstops for Concrete



**W**aterstops play a critical role in the integrity of concrete structures. They provide a fluid-tight diaphragm when embedded in, and running through concrete joints. Earth Shield® Polyvinyl Chloride Waterstop (PVC) is the perfect solution for most water and wastewater applications. Earth Shield® PVC Waterstop is manufactured from prime virgin resin and is the trusted choice for environmental engineered concrete structures.

J P Specialties, Inc. is the leading manufacturer of chemical resistant waterstop and related concrete accessories. We invented the technology used to mechanically weld thermoplastic waterstops.

Earth Shield® PVC Waterstop  
Phone: 800-821-3859; 951-763-7077  
Fax: 951-763-7074

[www.earthshield.com](http://www.earthshield.com)



## Earth Shield® Polyvinyl Chloride (PVC) Waterstop Basic Use

Earth Shield® Polyvinyl Chloride (PVC) Waterstop is used as a fluid-tight diaphragm, embedded in concrete, across and along the joint, for environmental engineered concrete structures.



Earth Shield® Flexible PVC Waterstops are resistant to a wide range of water and wastewater treatment chemicals and are certified to meet or exceed the performance requirements of CRD C572-74.

## Typical Applications

- Water treatment plants
- Wastewater treatment plants
- Dams
- Locks and canals
- Tunnels and culverts
- Foundations

## Earth Shield® Advantages

- Outstanding fluid resistance to a wide range of aqueous-based water and waste water treatment chemicals
- Meets ACI 350 "Code Requirements for Environmental Engineering Concrete Structures"
- CRD C572-74 compliant

## Installation

Install Earth Shield® Flexible PVC Waterstop in all concrete joints. Waterstop should be centered in, and run the extent of the joint. All changes of directions should be prefabricated, leaving only butt-welding for the field. If installing in an expansion joint, keep center bulb unembedded to allow it to accommodate movement as designed. Use optional factory installed brass eyelets (or #3 hog rings) and tie wire to secure waterstop to reinforcing steel to avoid displacement during the concrete pour. Splice straight lengths of waterstop and Shop Made Fittings to straight lengths, with an ST-10® In-Line Waterstop Splicer with the iron temperature set to 350°F to 380°F. More detailed installation instructions are in our Standard 3-part Specifications.

## Suggested Proprietary Short Form Guide Specification Section 03150 (Master Format 2004 – 03 15 13) Flexible PVC Waterstop

Waterstop indicated in drawings and specifications for contraction (control), expansion and construction joints shall be Earth Shield® Polyvinyl Chloride (PVC) Waterstop Part No. ##### [Designer insert appropriate part number here] as manufactured by J P Specialties, Inc.; Murrieta, CA 92562; Phone 951-763-7077

1. Flexible Polyvinyl Chloride (PVC) Waterstop shall be manufactured with prime virgin resin.
2. Flexible Polyvinyl Chloride (PVC) Waterstop shall be independently certified for use in potable water per NSF/ANSI Standard 61. Third-party certified documentation to be provided by the manufacturer.
3. No equals or substitutions allowed.

Property	Test Method	Required Results
Specific Gravity	ASTM D792	1.38 to 1.40
Shore A Hardness (15 sec.)	ASTM D2240	77±3 at 25°C (77°F)
Tensile Strength	ASTM D638	2,100 psi
Ultimate Elongation	ASTM D638	400%
Stiffness in Flexure	ASTM D747	700 psi
Tear Resistance	ASTM D624	320 lbs./inch
Brittle Point	ASTM D746	-37°C (-35°F)
Accelerated Extraction Tensile Strength	Corps of Engineers	2,005 psi
Accelerated Extraction Elongation	Corps of Engineers	390%
Effect of Alkali Weight Change	CRD C572-74	+0.11%
Effect of Alkali Hardness Change	CRD C572-74	-0.6 points
Drinking Water Safe	NSF/ANSI 61 	Waterstop certified by NSF for use in potable water

# Waterstop Accessories

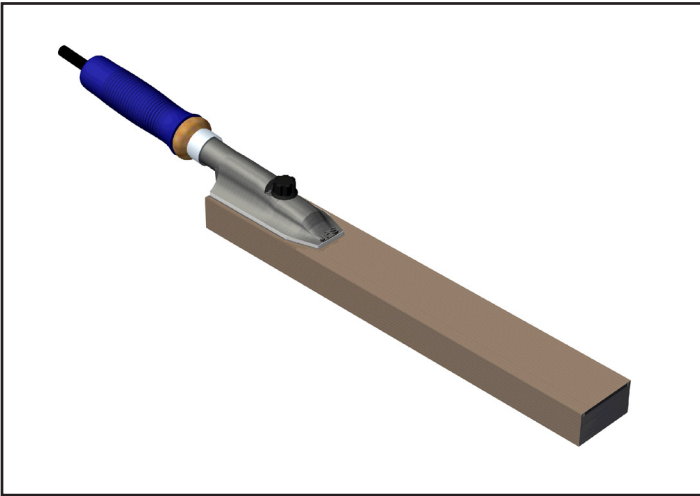

## Waterstop Splicing Irons

JPS Standard Irons are specifically designed for welding waterstops and other thermoplastic extruded profiles (expansion joints, seals, etc.). The temperature control can be adjusted from 250°F to 500°F to accommodate various ambient conditions and different polymers. All JPS Standard Irons are constructed with the highest quality components.

- *Peel and Stick Teflon® Cover included*
- *Heavy-duty vinyl grip and wood handle*
- *8-foot, CSA & UL certified, outdoor use power cable*
- *Adjustable temperature with “Off” position*

## ST-10 Waterstop Splicing Table

The ST-10® was designed and patented by J P Specialties as the perfect solution for producing high-tensile strength, leakproof welds on thermoplastic waterstops such as PVC, HDPE, LDPE, TPER, and TPV. New quality assurance standards in today’s waterstop specifications mandate tensile testing across field welded joints, usually requiring tensile strength 80% or better of the parent material. Waterstops welded with the ST-10® assure the Contractor that their workmanship will yield results conducive to these rigorous requirements. The ST-10® is also an extreme labor saver, taking a two man job — welding waterstop — and taking it down to just one man.

- *Easy to use*
- *Aligns the waterstop*
- *Portable, lightweight*
- *Weather resistant*
- *Minimizes fumes (maximizes safety)*
- *High tensile welds*
- *Welds under pressure, eliminating air bubbles*



# Ribbed Centerbulb

## for Moving and Non-Moving Joints

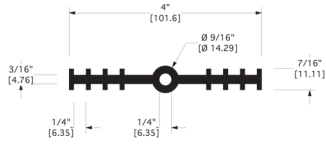

**PVC436** (with eyelets: EYPVC436)  
**4\"/>**

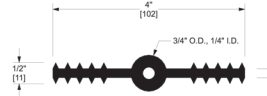

**PVC438** (with eyelets: EYPVC438)  
**4\"/>**

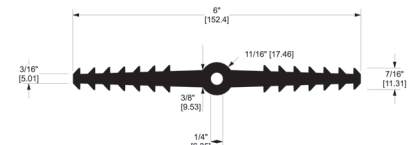

**PVC605** (with eyelets: EYPVC605)  
**6\"/>**

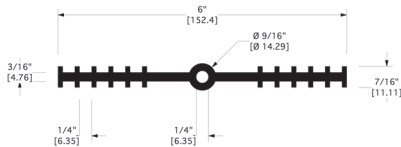

**PVC636** (with eyelets: EYPVC636)  
**6\"/>**

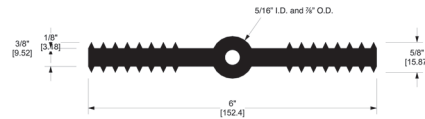

**PVC638** (with eyelets: EYPVC638)  
**6\"/>**

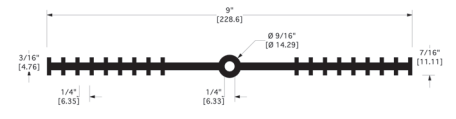

**PVC936** (with eyelets: EYPVC936)  
**9\"/>**

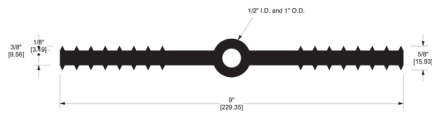

**PVC938** (with eyelets: EYPVC938)  
**9\"/>**

# Flat Strip

## Resists High Head Pressure

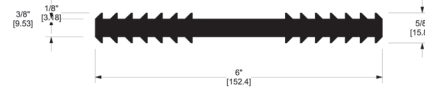

**PVC637** (with eyelets: EYPVC637)  
**6\"/>**

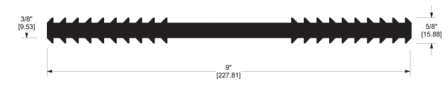

**PVC937** (with eyelets: EYPVC937)  
**9\"/>**



# Base Seal (aka Rearguard)

## for Flatwork and Bund Wall Applications

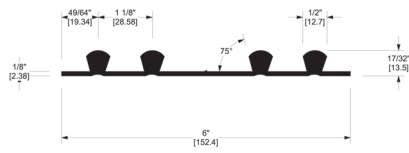

**PVC206**  
**6" Base Seal Waterstop**  
 50 ft Head of H<sub>2</sub>O • 50 lft/roll • .89 lbs/lft

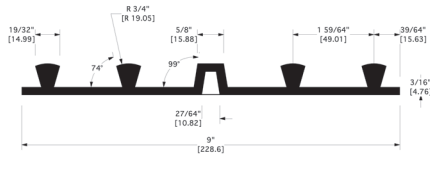

**PVC211**  
**9" Base Seal Waterstop**  
 75 ft Head of H<sub>2</sub>O • 50 lft/roll • 1.72 lbs/lft

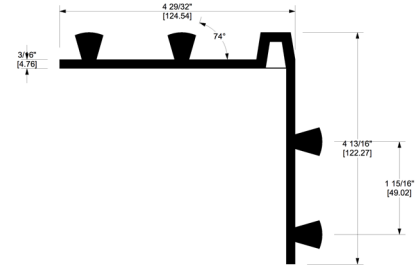

**PVC215**  
**6" Corner Seal Waterstop**  
 50 ft Head of H<sub>2</sub>O • 10 lft/length • 1.9 lbs/lft

# Retrofit Waterstop Systems

## for New to Existing Concrete Joints

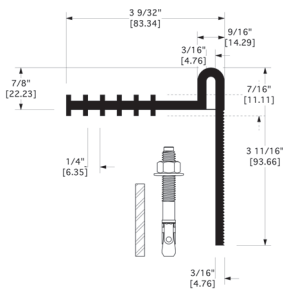

**PVC320L** (with eyelets: EYPVC320L)  
**Retrofit Waterstop System**  
*(Includes all batten bars and anchors)*  
 125 ft Head of H<sub>2</sub>O • 10 lft/length • 2 lbs/lft

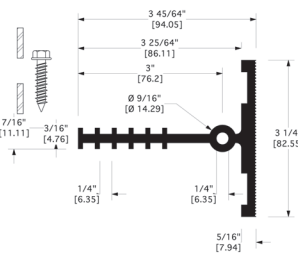

**PVC325T** (with eyelets: EYPVC325T)  
**Retrofit Waterstop System**  
*(Includes all batten bars and anchors)*  
 75 ft Head of H<sub>2</sub>O • 10 lft/length • 2 lbs/lft

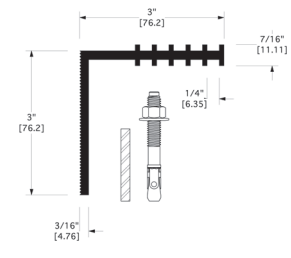

**PVC336L** (with eyelets: EYPVC336L)  
**Retrofit Waterstop System**  
*(Includes all batten bars and anchors)*  
 125 ft Head of H<sub>2</sub>O • 10 lft/length • 2 lbs/lft

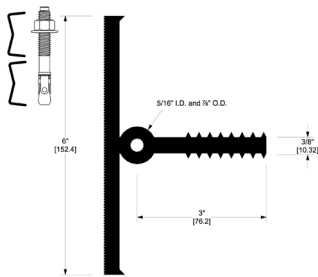

**PVC399T** (with eyelets: EYPVC399T)  
**Retrofit Waterstop System**  
*(Includes all batten bars and anchors)*  
 150 Head of H<sub>2</sub>O • 10 lft/length • 4 lbs/lft

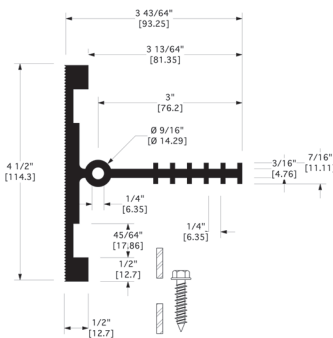

**PVC450T** (with eyelets: EYPVC450T)  
**Retrofit Waterstop System**  
*(Includes all batten bars and anchors)*  
 75 ft Head of H<sub>2</sub>O • 10 lft/length • 2 lbs/lft

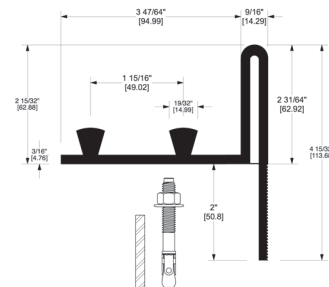

**PVC621L**  
**Large Movement Retrofit**  
*(Includes all batten bars and anchors)*  
 75 ft Head of H<sub>2</sub>O • 10 lft/length • 4 lbs/lft

Contact the "Waterstop Experts" at 951-763-7077

# Special Shapes for Large Movement Joints

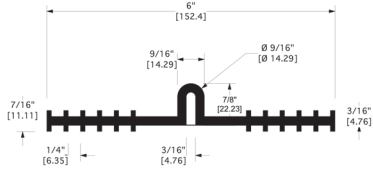

**PVC678** (with eyelets: EYPVC678)  
**6" Tear Web Waterstop**  
 100 ft Head of H<sub>2</sub>O • 50 lft/roll • .87 lbs/lft

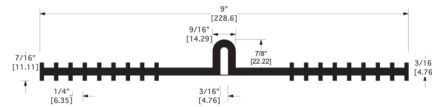

**PVC978** (with eyelets: EYPVC978)  
**9" Tear Web Waterstop**  
 125 ft Head of H<sub>2</sub>O • 50 lft/roll • 1.2 lbs/lft



# CalTrans California DOT Waterstop

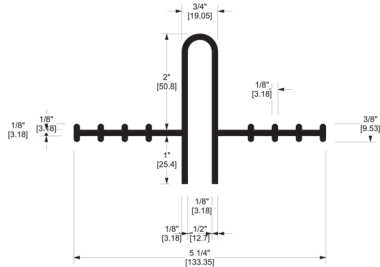

**PVC701** (with eyelets: EYPVC701)  
**5.25" CalTrans W-1 / 2 Waterstop**  
 50 ft Head of H<sub>2</sub>O • 50 lft/roll • 1.1 lbs/lft

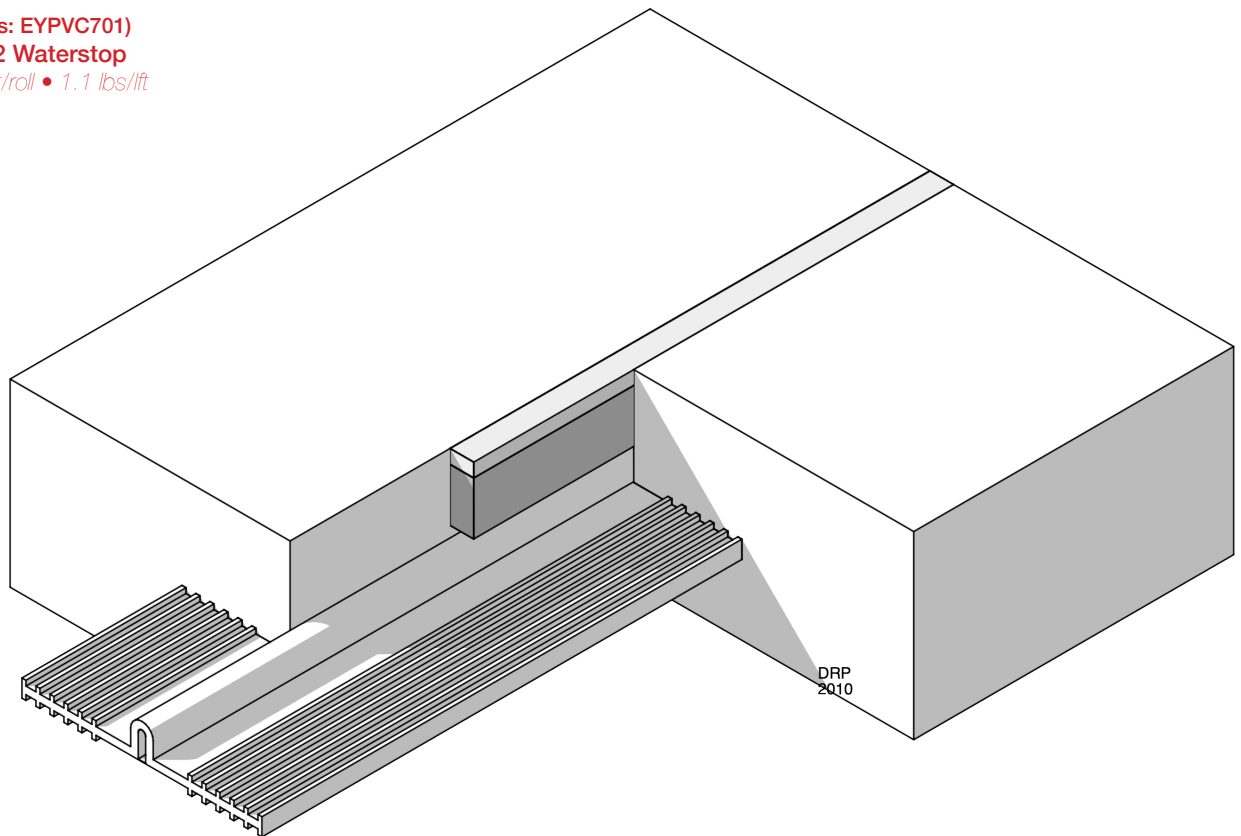

Contact the "Waterstop Experts" at 951-763-7077

# Dumbbell

## Large Web Thickness for Heavy Concrete

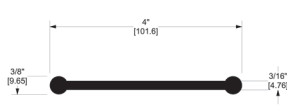

**PVC443**  
**4" Dumbbell Waterstop**  
 65 ft Head of H<sub>2</sub>O • 50 lft/roll • .49 lbs/lft



**PVC647**  
**6" Dumbbell Waterstop**  
 100 ft Head of H<sub>2</sub>O • 50 lft/roll • .71 lbs/lft



**PVC648**  
**6" Dumbbell Waterstop**  
 125 ft Head of H<sub>2</sub>O • 50 lft/roll • 1.59 lbs/lft



**PVC948**  
**9" Dumbbell Waterstop**  
 150 ft Head of H<sub>2</sub>O • 50 lft/roll • 2.55 lbs/lft

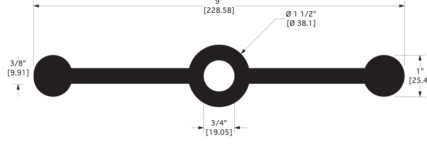

**PVC949**  
**9" Dumbbell Centerbulb Waterstop**  
 150 ft Head of H<sub>2</sub>O • 50 lft/roll • 3.1 lbs/lft

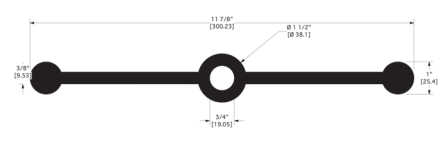

**PVC1149**  
**12" Dumbbell Centerbulb Waterstop**  
 225 ft Head of H<sub>2</sub>O • 50 lft/roll • 3.9 lbs/lft

# Need Chemical Resistance?

## Thermoplastic Vulcanizate Waterstop for Industry



Earth Shield® Thermoplastic Vulcanizate Waterstop (TPV), by J P Specialties, Inc., greatly expands the scope of conventional waterstop by offering unmatched chemical resistance to a broad spectrum of aggressive chemicals, solvents, and hot petroleum oils. Manufactured NSF certified, EPA-compliant waterstop profiles are available for new construction and retrofit, as well as the tools and accessories for proper field installation.

# Made in t

## CRD C572-74 Waterstops f

Manufactured  
with pride by



J P SPECIALTIES, INC.

# WWW



# the U.S.A.

J P Specialties, Inc. manufactures a wide range of high-quality waterstop and waterstop accessories for the concrete construction industry. Our Earth Shield® line of flexible PVC waterstop is designed to fluid-proof construction, expansion, and contraction joints of environmental engineered concrete structures. Our waterstop welding equipment is used industry-wide as the standard for quality, high tensile strength waterstop welds. Knowing that a waterstop will only offer a fluid-tight barrier if change of directions are done properly, J P Specialties has been a leader since 1954 in Prefabricated Waterstop Modules and Shop Made Fittings.

## Certified PVC for Concrete

## WWW.EARTHSHIELD.COM

# Waterstop Shop Made Fittings

## Ensure A Quality, Leak-Proof Project

Shop Made Fittings are recognized and specified worldwide by major engineering firms. The U.S. Army Corps of Engineers also specified Shop Made Fittings in the July 1995 revision of CEGS Section 03250. Shop Made Fittings are specified because they work. Edge-welding waterstop severely compromises the integrity of any project. Even the limited movement of concrete during the coefficient of expansion and contraction can be too much for edge welded waterstop. The edge welded waterstop lacks the proper tensile strength and does not maintain the characteristics of the parent material (bulb or rib continuity). Consequently, the waterstop often tears at the most critical junction: the change of direction. Since all waterstops are designed to act as a continuous, fluid-tight diaphragm which fluids (generally water) traverse, the structure that uses edge welded waterstop will naturally leak, as fluids migrate to any tears in the weld and pass through to the other side of the joint.

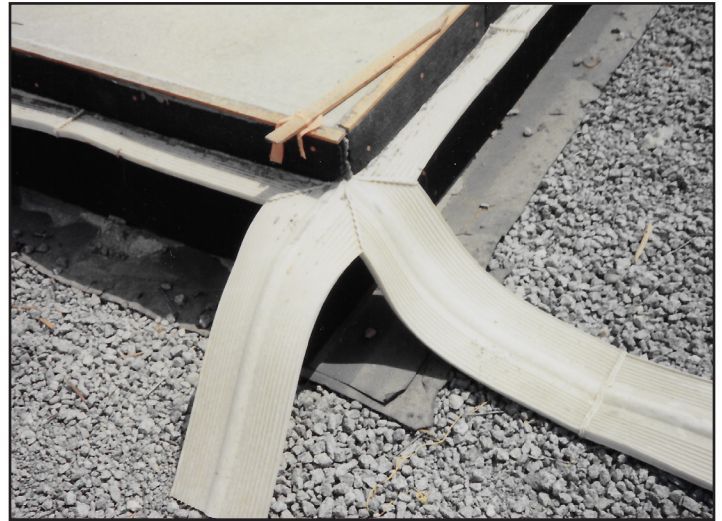

Structures that use Shop Made Fittings will significantly reduce these waterstop failures. The tensile strength of the weld will be at least 80% of the parent material, maintaining the continuity of the bulbs and ribs across the weld. In other words, the waterstop will perform as intended and last the life of the structure.

J P Specialties has an extensive library of CAD drawings that illustrate the many uses of various Shop Made Fittings and explain waterstop's role in creating a fluid-tight structure.

J P Specialties certified welding crew efficiently manufactures large quantities of top-quality Shop Made Fittings with speed on our exclusive XLT-2000 Waterstop Splicing Tables. Therefore, we can pass the savings on to the end user: the contractor. Besides saving money, the contractor who uses Shop Made Fittings will save time. A standard flat cross has twelve cuts and seven welds. By using Shop Made Fittings, all of the cuts and three of the welds are eliminated. The number of welds is further reduced by using modules.

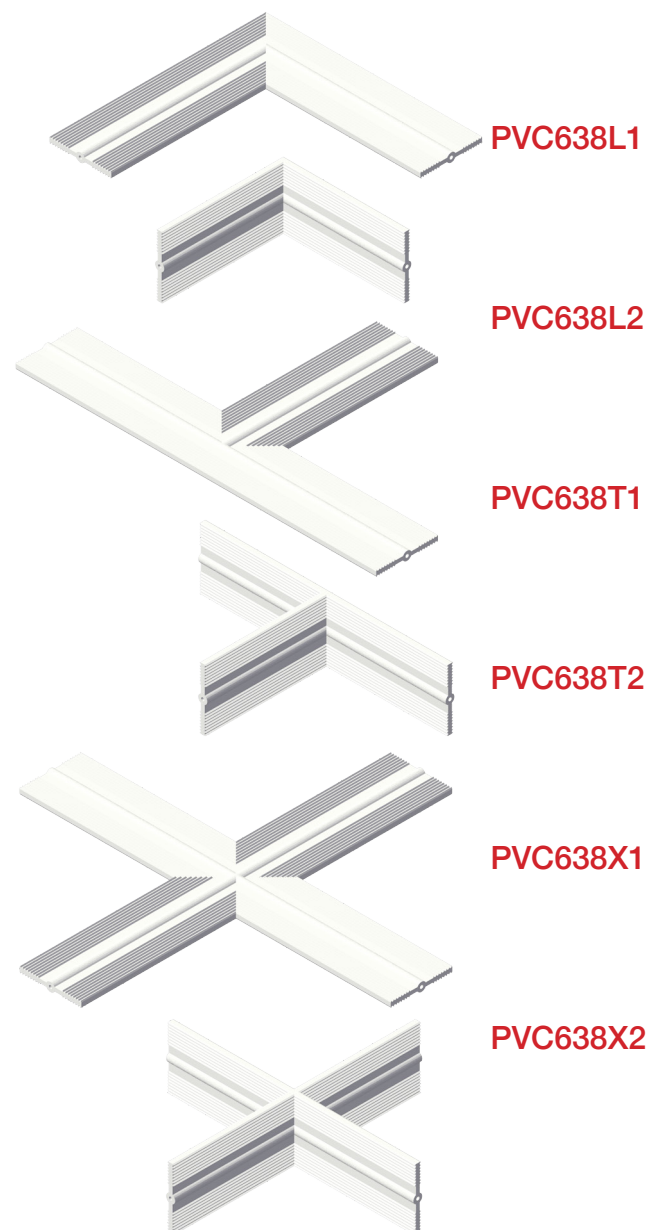

# Retrofit Column and Pipe Fitting

Earth Shield® has solved a long-standing problem for engineered concrete structures with circular protrusions, such as columns, pipes, piers, and pilasters. The problem: how to permanently seal the concrete joint when cast-in-place concrete is formed against an existing circular member. The solution: Earth Shield® Column & Pipe Fitting (part no. PVC320LC1.XX\* [\*XX is the diameter in inches]) is manufactured with a flexible PVC and stainless steel anchoring hardware. A single laborer on the job site can quickly install the column fitting and its associated hardware. Just apply an epoxy gel bed to the existing surface; place the polymer ring into the epoxy gel bed; heat weld the single opening on the polymer ring using a waterstop splicing iron; and finally, complete the system with the stainless steel closure ring.

The Earth Shield® system functions as an internal dam, centrally located within the cast concrete, to stop water from penetrating the joint. The tear-web design of the PVC320L profile, enable the column fitting to function equally well in expansion (isolation) joints and construction joints.

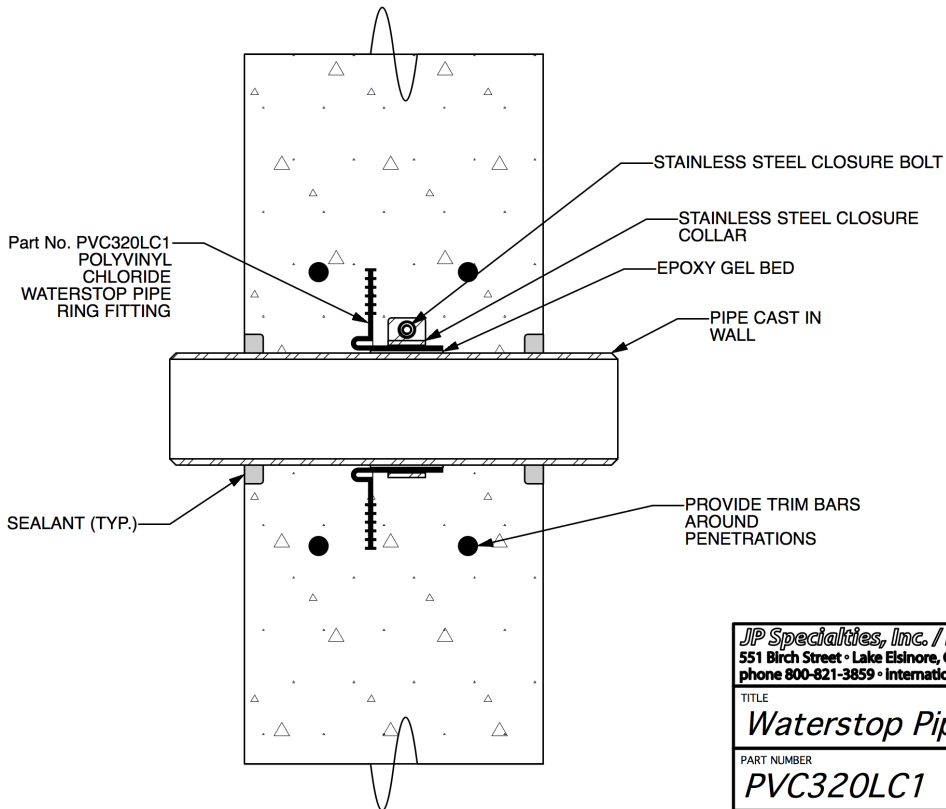
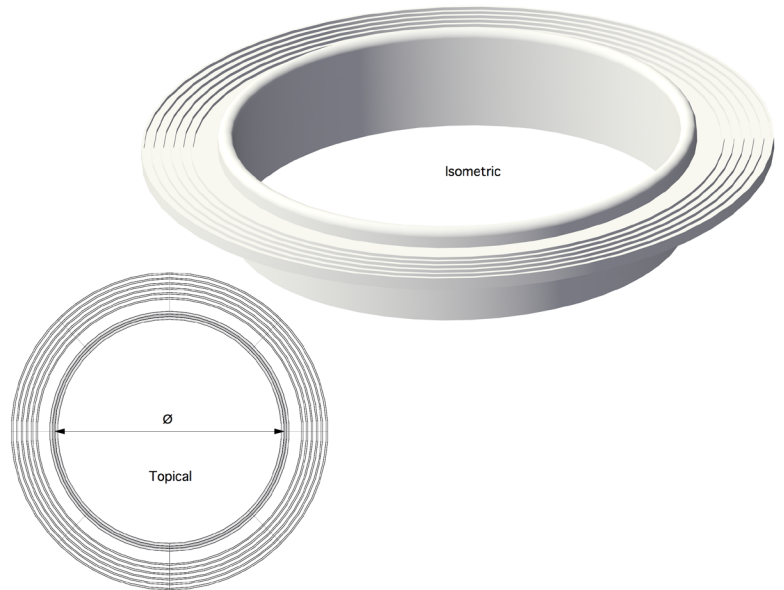

<b>JP Specialties, Inc. / Earth Shield®</b> 551 Birch Street • Lake Elsinore, CA 92530 www.jp-specialties.com phone 800-821-3859 • International 951-674-6869 • fax 951-674-1315		
TITLE <b>Waterstop Pipe Fitting</b>		
PART NUMBER <b>PVC320LC1</b>	DRAWN BY <b>DRP</b>	DATE <b>05/18</b>
CAD FILE NAME <b>ACI350_2R_Waterstop_Collar</b>	APPROVALS	SIZE <b>A</b>

Contact the "Waterstop Experts" at 951-763-7077

# Availability

## National and International Warehouses

Earth Shield® Flexible Polyvinyl Chloride Waterstop is readily available from a variety of sources:

- **Preferred Regional Stocking Partners** — *We are partners with some of the very best Concrete Accessories Distributors in the world. All our preferred partners have large stocking inventories and are factory trained to provide the utmost in on-site assistance.*
- **Distributor Sales** — *Earth Shield® can be special ordered from many distributor sales channels throughout the world.*
- **Factory Direct** — *Earth Shield® may be contacted directly for project quotation and product purchase (call 800-821-3859).*

# Services

- *Project and Product Certification — We assist the Design Engineer and Project Owner with individual project and product certification. When you specify our waterstop, you can be assured it is the correct product for your application.*
- *On-site waterstop welding certification class — \$500.00 flat fee*
- *On-site waterstop installation assistance — \$1,000.00 per day*
- *Telephone and Web-based assistance — Always FREE*

Distributed by:



Visit Earth Shield® on the Web at  
**[www.earthshield.com](http://www.earthshield.com)**

## Earth Shield® Waterstop Limited Warranty

J P Specialties, Inc. warrants to the Buyer that this product is new and will be free from defects and will perform as represented in writing subject to the two (2) following conditions: First, the application of the product and the concrete construction practices used in the application are in accordance with J P Specialties, Inc. recommendations; and, Second, the Buyer has selected the proper product for the specific application required.

Any information supplied in good faith by J P Specialties, Inc. with respect to its products is believed to be correct. J P Specialties, Inc. Makes no representation or warranties, expressed or implied, as to the accuracy or completeness of such information.

The exclusive remedies of the Buyer and the limit of the liability of J P Specialties, Inc. from any and all losses or damages resulting from the use of this product shall be either full refund of the purchase price to the Buyer of this product or the replacement of the quantity of product purchased by the Buyer at the discretion of J P Specialties, Inc.

All supplied testing data has been performed by independent testing laboratories.

Earth Shield® Polyvinyl Chloride Waterstop  
Phone: 800-821-3859; 951-763-7077  
Fax: 951-763-7074

[www.earthshield.com](http://www.earthshield.com)



 [www.facebook.com/waterstop](https://www.facebook.com/waterstop)

## SECTION 03150 — WATERSTOPS FOR CONCRETE JOINTS — rev. 01/12/19

### \*\*\*\*\* MasterFormat™ 2004 — Section 03 15 13 \*\*\*\*\*

This specification is available in a variety of computer formats on CD-ROM or DVD. Contact Earth Shield® Technical Sales for more information. It can also be found on the web at [www.earthshield.com](http://www.earthshield.com).

## Suggested Short Form Guide Specification

### Flexible PVC Waterstop for Concrete Joints

Waterstop indicated in drawings and specifications for contraction (control), expansion, and construction joints shall be Earth Shield® Polyvinyl Chloride (PVC) Waterstop **Part No. ####** [Designer insert appropriate part number here] as manufactured and available from J P Specialties, Inc. — Murrieta, CA, USA 92562 — Phone 800-821-3859; 951-763-7077; Fax 951-763-7074; [www.earthshield.com](http://www.earthshield.com); E-mail [davidp@earthshield.com](mailto:davidp@earthshield.com)

1. Flexible Polyvinyl Chloride (PVC) Waterstop shall be manufactured with prime virgin resin.
2. Flexible Polyvinyl Chloride (PVC) Waterstop shall be independently certified for use in potable water per NSF/ANSI Standard 61. Third-party certified documentation to be provided by the manufacturer.
3. No equals or substitutions allowed.

### PVC Waterstop Shop Made Fittings for Directional Changes

Intersection and change of direction waterstops shall be factory fabricated as manufactured and available from J P Specialties, Inc. — Murrieta, CA, USA 92562 — Phone 800-821-3859; 951-763-7077; Fax 951-763-7074; Web [www.earthshield.com](http://www.earthshield.com); E-mail [davidp@earthshield.com](mailto:davidp@earthshield.com) and installed at all locations on the drawing by the Contractor. The Contractor shall only weld straight lengths of waterstop with all change of directions (fittings) being fabricated and supplied by Manufacturer.

1. No equals or substitutions allowed.

## Suggested Long Form Guide Specification

### PART 1 GENERAL

1. Provision Includes
  - A. Embedded waterstop in concrete including contraction, expansion and construction joints creating a continuous diaphragm to prevent the passage of fluid.
  - B. The use of nonmetallic waterstops for use in concrete joints subjected to chlorinated water, sea water, and many waterborne chemicals.

1. References

The publications listed below form a part of this specification to the extent referenced. The publications are referred to in the text by basic designation only.

- A. American Society for Testing and Materials (ASTM)
  - B. Federal Specifications
    1. COE CEGS-03250 July 1995 Guide Specification for Military Construction.
    2. Corps of Engineers — CRD C572-74
    3. Bureau of Reclamation — C-902
  - C. Canadian General Standards Board
    1. 41-GP-35M Types 1 and 3
  - D. NSF International
    1. NSF/ANSI Standard 61 Certification for Drinking Water System Components — Health Effects.
3. Submittal Procedures
    - A. Flexible PVC Waterstop
      1. Earth Shield® PVC Waterstop submittal shall contain the following:

## SECTION 03150 – WATERSTOPS FOR CONCRETE JOINTS – rev. 01/12/19

### \*\*\*\*\* MasterFormat™ 2004 – Section 03 15 13 \*\*\*\*\*

- a. Samples of each size and shape to be used.
  - b. Plate drawings of the waterstop profile indicating all dimensions.
  - c. Shop drawings of shop made fittings to be provided by the manufacturer or prepared by the contractor.
  - d. Manufacturer's Literature, MSDS sheets, installation, safety, and splicing instructions.
  - e. Certificate of compliance to physical properties outlined in this specification with third-party independent test reports (all testing reports within three years of date of submittal).
2. Flexible PVC Waterstop and Splices – Specimens identified to indicate manufacturer, type of material, size, quantity of material, and shipment or lot represented. Each sample shall be not less than 6 inches long of each type, size, and lot furnished. One splice sample of each size and type for every 50 splices made in the shop and every 10 splices made at the job site. The splice samples shall be made using straight run pieces with the splice located at the mid-length of the sample and finished as required for the installed waterstop. The total length of each splice shall be not less than 12 inches long.

#### 4. Delivery and Storage

Material delivered and placed in storage shall be stored off the ground and protected from sunlight, moisture, dirt, and other contaminants.

### PART 2 PRODUCTS

#### 1. Flexible PVC Waterstop

Intersection and change of direction waterstops shall be factory fabricated.

##### A. Manufacturer:

**J P Specialties, Inc.** – Murrieta, CA, USA 92562 – Phone 800-821-3859; 951-763-7077; Fax 951-763-7074; Web [www.earthshield.com](http://www.earthshield.com); E-mail [davidp@earthshield.com](mailto:davidp@earthshield.com)

- B. Flexible Polyvinyl Chloride (PVC) Waterstop shall be manufactured from a prime virgin, flexible polyvinyl chloride (PVC) compound, containing no pigments, scrap or reclaimed material.
- C. Flexible Polyvinyl Chloride (PVC) Waterstop shall be certified for use in potable water per NSF/ANSI Standard 61. Third-party certified documentation to be provided by manufacturer.

**Flexible Polyvinyl Chloride (PVC) Waterstop shall conform to the following typical physical properties:**

Property	Test Method	Required Results
Specific Gravity	ASTM D 792	1.38 to 1.40
Shore A Hardness (15 sec.)	ASTM D 2240	77±3 at 25°C (77°F)
Tensile Strength	ASTM D638	2,100 psi
Ultimate Elongation	ASTM D638	400%
Stiffness in Flexure	ASTM D747	700 psi
Tear Resistance	ASTM D624	320 lbs./inch
Brittle Point	ASTM D746	-37°C (-35°F) No Failure
Accelerated Extraction Tensile Strength	Corps of Engineers	2,005 psi
Accelerated Extraction Elongation	Corps of Engineers	390%

**SECTION 03150 — WATERSTOPS FOR CONCRETE JOINTS — rev. 01/12/19**

**\*\*\*\*\* MasterFormat™ 2004 — Section 03 15 13 \*\*\*\*\***

<b>Property</b>	<b>Test Method</b>	<b>Required Results</b>
Effect of Alkali Weight Change	CRD C572-74	+0.11%
Effect of Alkali Hardness Change	CRD C572-74	-0.6 points
Drinking Water Safe	NSF/ANSI 61 	Waterstop certified by NSF for use in potable water

**PART 3 EXECUTION**

1. Waterstop, Installations and Splices — Waterstops shall be installed at the locations shown to form a continuous fluid-tight diaphragm. Adequate provision shall be made to support and completely protect the waterstops during the progress of the work. Any waterstop punctured or damaged shall be repaired or replaced. Exposed waterstops shall be protected during application of form release agents to avoid being coated. Suitable guards shall be provided to protect exposed projecting edges and ends of partially embedded waterstops from damage when concrete placement has been discontinued. Splices shall be made by certified, trained personnel using approved equipment and procedures.
  - A. Flexible PVC Shop Made Fittings — Fittings shall be shop made using a machine specifically designed to mechanically weld the waterstop. A miter guide, proper template (profile dependent), and portable power saw shall be used to miter cut the ends to be joined to ensure good alignment and contact between joined surfaces. The splicing of straight lengths shall be done by squaring the ends to be joined and using an ST-10® waterstop splicing tool. Continuity of the characteristic features of the cross section of the waterstop (ribs, tabular center axis, protrusions, etc.) shall be maintained across the splice.
  - B. Flexible PVC Waterstop — The splicing of straight lengths shall be done by squaring the ends to be joined and using an ST-10® waterstop splicing tool utilizing a thermoplastic splicing iron with a non-stick surface specifically designed for waterstop welding. The correct temperature (350°F to 380°F) shall be used to sufficiently melt without charring the plastic. The spliced area, when cooled, shall show no signs of separation, holes, or other imperfections when bent by hand in as sharp an angle as possible.
2. Preparation
  - A. Uncoil waterstop 24 hours prior to installation for ease of handling and fabrication.
  - B. Position waterstop to ensure proper distance from steel reinforcing bars to prevent rock pockets and honeycomb (see installation section 3.04).
  - C. Protect waterstop from damage during progress of work.
  - D. Clean concrete joint after first pour to remove debris and dirt.
3. Examination/Inspection
  - A. Prior to placement of concrete notify engineer for field inspection approval.
  - B. Inspect waterstop and field splices for defects and conformance to Quality Assurance Standard section 3.05.
  - C. Upon inspection of waterstop installation, replace any damaged or unacceptable waterstop and dispose of defective material.
4. Installation
  - A. Position waterstop in joint as indicated on drawings.
  - B. Center waterstop on joint, with approximately one-half of waterstop width to be embedded in concrete on each side of the joint.

**SECTION 03150 — WATERSTOPS FOR CONCRETE JOINTS — rev. 01/12/19**

**\*\*\*\*\* MasterFormat™ 2004 — Section 03 15 13 \*\*\*\*\***

- C. Allow clearance between waterstop and reinforcing steel of a minimum two times the largest aggregate size. Prevent rock pockets and air voids caused by aggregate bridging.
  - D. Ensure centerbulb is not embedded at expansion joints.
  - E. Secure waterstop in correct position using optional factory-installed brass eyelets (or JPS hog rings crimped between last two ribs on 12 inch maximum centers), and wire tie to adjacent reinforcing steel. Center-to-center spacing may be increased upon written request and approval from ENGINEER.
  - F. Carefully place concrete without displacing waterstop from proper position.
  - G. Thoroughly and systematically vibrate concrete in the vicinity of the joint, and to maximized intimate contact between concrete and waterstop.
  - H. After first pour, clean unembedded waterstop leg to ensure full contact of second concrete pour. Remove laitance, spillage, form oil and dirt.
5. Quality Assurance — Edge welding will not be permitted. Centerbulbs shall be compressed or closed when welding to non-centerbulb type. Waterstop splicing defects which are unacceptable include, but are not limited to the following:
- A. Tensile strength not less than 60 percent of parent sections.
  - B. Free lap joints.
  - C. Misalignment of centerbulb, ribs, and end bulbs greater than 1/16 inch.
  - D. Misalignment which reduces waterstop cross section more than 15 percent.
  - E. Bond failure at joint deeper than 1/16 inch or 15 percent of material thickness.
  - F. Misalignment of waterstop splice resulting in misalignment of waterstop in excess of 1/2 inch in 10 feet.
  - G. Visible porosity in the weld.
  - H. Charred or burnt material.
  - I. Bubbles or inadequate bonding.
  - J. Visible signs of splice separation when cooled splice (24 hours or greater) is bent by hand at sharp angle.

END OF SECTION

*All information is presented in good faith and the results are believed to be accurate. All testing was done independently of Earth Shield® and J P Specialties, Inc.; therefore, neither Earth Shield® nor J P Specialties, Inc. makes any guarantee as to the testing data accuracy or the results obtained.*



## Operating Safety

- Allow only ONE PERSON to work on Splicing Iron at a time.
- Only qualified personnel should operate splicing iron.
- Keep children, bystanders, and animals, at least twenty (20) feet away from the work area.
- Do not operate under the influence of alcohol or drugs.
- Always unplug the iron when not in Use.
- Never operate under the influence of medications, drugs or alcohol.
- Iron operates at very high temperature and can burn flesh or cause ignition, even after being unplugged (until cool).
- Never, under any circumstances, alter your Splicing Iron. Altering the equipment, or using the equipment in such a way as to change its design capabilities and capacities, could result in serious or fatal injury and WILL VOID THE WARRANTY.

## Warranty

*J P Specialties, Inc. warrants this splicing iron to the original user against defective material or workmanship for a period of 90 days from the purchase date.*

## Safety Manual

Do not operate the Splicing Iron unless you read and understand the instructions and warnings in this manual. If any doubt or question arises about the correct or safe method of performing anything found in this manual contact JP Specialties, Inc.

## Personal Protection

- Always wear protective gear including but not limited to:
  - ✓ Temperature resistant gloves
  - ✓ Safety goggles
  - ✓ Protective shoes/boots
  - ✓ Respirator in indoor confined spaces
- Ensure all electrical connections are in good working order prior to plugging in Splicing Iron.

## Worksite Safety

- Do not leave plugged/unplugged iron lying around the work area.
- NEVER use Splicing Iron on slippery, wet, or muddy surfaces. The location should be flat, dry, and free from any tall grass, brush, or ignitable objects.
- Welding should be done in a well ventilated area. In confined areas, a respirator should be worn as melting plastic waterstop fumes may be harmful to your health.
- NEVER use your Splicing Iron at night.

J P Specialties, Inc.

Waterstop Splicing Iron Safety Manual and Users Guide

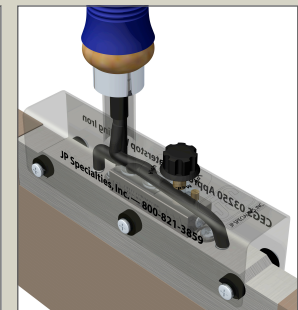
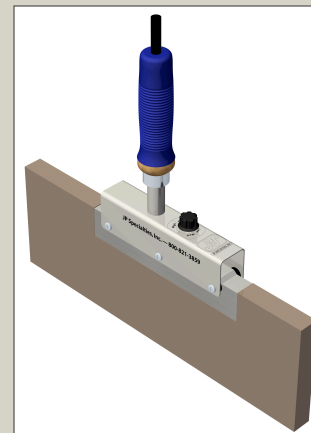
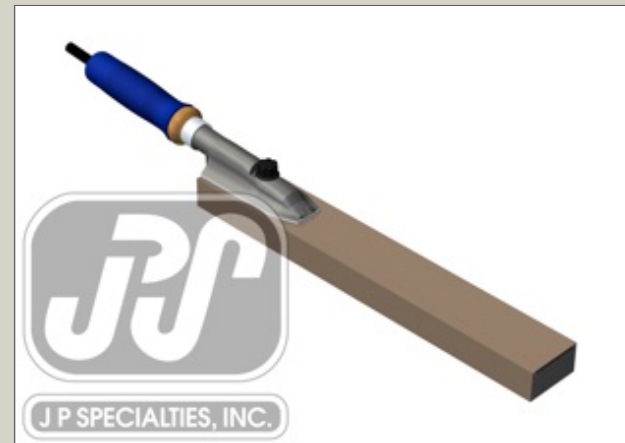

J P SPECIALTIES, INC.  
25811 JEFFERSON AVENUE  
MURRIETA, CA 92562

TOLL FREE 800-821-3859  
PHONE 951-763-7077  
FAX 951-763-7074

[WWW.JPSPECIALTIES.COM](http://WWW.JPSPECIALTIES.COM)  
[JPSPEC@JPSPECIALTIES.COM](mailto:JPSPEC@JPSPECIALTIES.COM)

## Waterstop Splicing Iron Job Site Installation User Guide

Follow all of the instructions contained in this booklet to ensure a safe procedure and structurally sound waterstop welds.

### Splicing Technique:

A initial warm up time of approximately 15 minutes is required to heat up splicing iron to the required temperature. Preheat Iron up to the following:

- For TPV/TPER Waterstop: 410 to 430°F
- For PVC Waterstop: 350 to 380°F

It is recommended to verify temperature using an external thermometer.

**NOTE: The Peel and Stick Teflon® Cover is to remain on the iron during the welding process. DO NOT REMOVE.**

**CAUTION: Too high of a temperature will result in damage to waterstop welds, splicing iron cover, and possibly splicing iron.**

1. Always cut square ends before welding waterstops. Never weld to extruded ends. Use flat work table to create field splices. Work area should be solid and have access to power supply and have jigs and fixtures to aid splicing.
2. Cut ends square, using a razor knife or circular saw equipped with a carbide tipped blade (10" diameters with 40 teeth) to ensure matching edges.
3. Preheat the iron to the desired temperature ranges. Place iron between butt ends. Keep waterstops in place until approximately 3/16" bead forms on each side of waterstops. Quickly remove splicing iron and gently press waterstops ends together until they bond (approximately 3 to 5 minutes or cool to touch). Cold water may be sprayed on waterstops to expedite the bond. **NOTE: When welding TPV/TPER, if you do not join ends quickly, the melted material will skin over, resulting in an inadequate bond.**

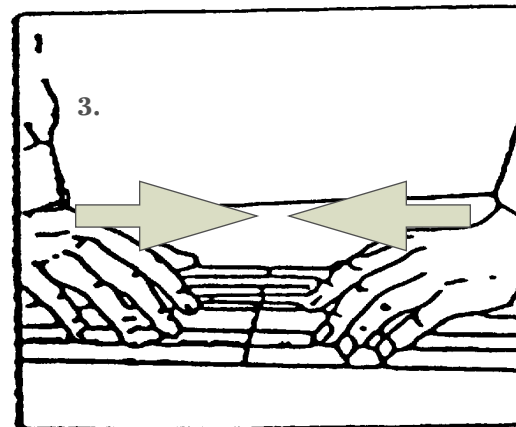
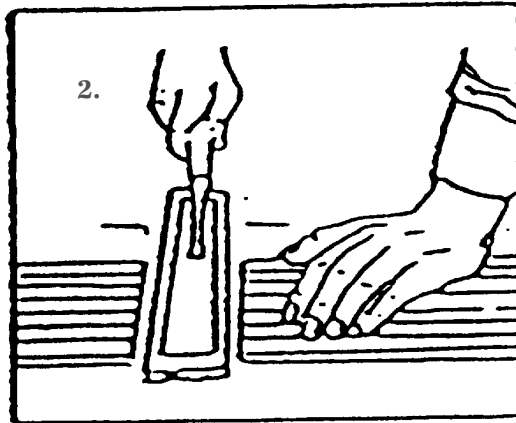
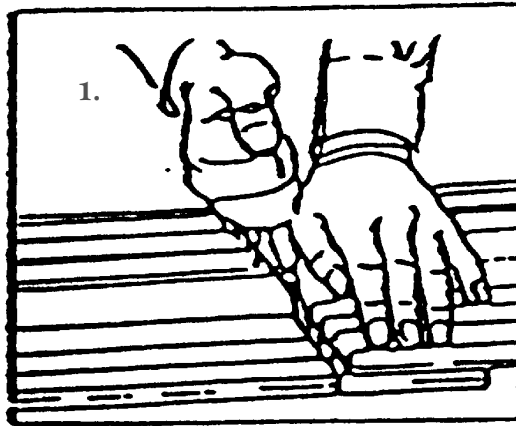

## Electrical Safety & Standards

1. Ensure appropriate electrical connections are in good working order.
2. Do not alter the tool in any way. Doing so could be a hazard and void the warranty.
3. Keep iron away from water and never operate with wet hands.
4. Do not use the Splicing Iron with a damaged cord.
5. Never use the Splicing Iron with non-regulated voltages.
6. Understand the Safety Manual and User Guide before plugging in the Splicing Iron.

### WATERSTOP SPLICING IRON TROUBLESHOOTING GUIDE

SYMPTOM	REMEDY
No Heat	<ol style="list-style-type: none"> <li>1. Have qualified personnel check for correct line voltage.</li> <li>2. If twist lock plug has been added, make certain all N.E.C. code has been followed and that all electrical connections are sound.</li> <li>3. Ensure GFCI is closed.</li> </ol>
Low Heat	<ol style="list-style-type: none"> <li>1. Have qualified personnel check for correct line voltage.</li> <li>2. Ensure generator has enough power for all tools in use.</li> <li>3. Ensure extension cord used is less than 50 feet in length and at least 12 gauge thick.</li> <li>4. If temperature has not been reached in 30 minutes contact the manufacturer.</li> </ol>

## SAFETY DATA SHEET

---

### SECTION I – IDENTIFICATION

---

J P Specialties, Inc. / Earth Shield Waterstop

CHEMICAL NAME: Flexible Polyvinyl Chloride

Mixture CAS-No.: Mixture

TRADE NAME: Earth Shield PVC Waterstop

---

### SECTION II – HAZARD IDENTIFICATION

---



#### **Flexible Polyvinyl Chloride**

**WARNING!** Hydrochloric (HCl) gas is evolved by combustion or by decomposition at temperatures higher than 200°C/400°F. Provide efficient exhaust at all operational areas capable of creating fumes to prevent inhalation or exposure.

Hot thermoplastic waterstop can cause burns. Wear personal protection equipment to prevent burns to skin.

Read the Safety Data Sheet (SDS) before handling or using this material.

**First Aid:** If exposed to HCl fumes, move to fresh air and flush skin or eyes with water for at least 10 minutes. Seek medical attention.

J P Specialties, Inc. / Earth Shield Waterstop  
25811 Jefferson Ave Murrieta, CA 92562  
+1 951-763-7077 [www.jpspecialties.com](http://www.jpspecialties.com)

---

### SECTION III-COMPOSITION INFORMATION ON REGULATED INGREDIENTS

---

MATERIAL	CAS#	Weight %
Vinyl Chloride	75-01-4	≤ 0.1ppm

---

### SECTION IV – FIRST AID MEASURES

---

EMERGENCY AND FIRST AID PROCEDURES: Remove affected person from area, if irritation persists, obtain medical attention.

#### INHALATION

Remove to fresh air. Obtain medical attention immediately if any irritation persists.

#### SKIN CONTACT

Flush with water to remove material from the skin. Obtain medical attention if any irritation persists.

#### EYE CONTACT

Flush with large amounts of water for 15 minutes. Obtain medical attention if any irritation persists.

#### INGESTION

No effect expected. If large amounts are ingested, seek medical attention. Only induce vomiting at the instructions of a physician.

---

### SECTION V - FIRE FIGHTING MEASURES

---

FLASH POINT (ASTM 1929): 735°F

EXTINGUISHING MEDIA: Water - air foams

SPECIAL FIRE FIGHTING PROCEDURES: Wear self-contained breathing apparatus.

UNUSUAL FIRE AND EXPLOSION HAZARDS: Upon prolonged heating, it decomposes, emitting hydrogen chloride (HCl), an irritating toxic gas.

---

### SECTION VI – ACCIDENTAL RELEASE MEASURES

---

STEPS TO BE TAKEN IN CASE MATERIAL IS SPILLED: Non Applicable.

WASTE DISPOSAL: Incinerate or dispose in landfill according to current local, state, and federal regulations.

---

### SECTION VII – HANDLING AND STORAGE

---

- Use the proper protective equipment during handling – gloves, safety glasses. Use good housekeeping practices
  - Store in a cool, dry location protected from extraneous heat, sparks and flame.
  - PRECAUTIONS TO BE TAKEN IN HANDLING AND STORING: Store in area below 100°F.
-

---

## SECTION VIII – EXPOSURE CONTROL/PERSONAL PROTECTION

---

RESPIRATORY PROTECTION: None required with adequate ventilation.

VENTILATION: Local exhaust recommended for fumes and vapors.

PROTECTIVE GLOVES: Gloves required when handling hot or molten PVC waterstop. EYE PROTECTION: Eye protection should be worn at all times.

### EXPOSURE GUIDELINES

MATERIAL	OSHA-PEL (mg/m <sup>3</sup> )	ACGIH TLV (mg/m <sup>3</sup> )
Calcium Carbonate	15	10

---

## SECTION IX -PHYSICAL AND CHEMICAL DATA

---

Appearance: Extruded Coils

Odor: No distinct odor

Boiling Point: N/A Solid

VAPOR PRESSURE: N/A

SOLUBILITY IN WATER: Insoluble

PERCENT VOLATILE MATTER BY WEIGHT: 0 - 0.3% as calculated from determinations made using EPA Method 24

SPECIFIC GRAVITY: 1.39 – 1.43

---

## SECTION X – STABILITY AND REACTIVITY

---

STABILITY: Stable

HAZARDOUS POLYMERIZATION: Will not occur.

CONDITIONS TO AVOID: Keep away from oxidizing agents and open flame. To avoid thermal decomposition do not overheat.

INCOMPATIBILITY: Incompatible with strong acids and oxidizing agents.

HAZARDOUS DECOMPOSITION PRODUCTS: Carbon monoxide, carbon dioxide, hydrogen chloride, and small amounts of hydrocarbons & metal oxides. Prolonged heating at 200C or short term heating at 250C may result in product decomposition and evolution of HCL and CO.

---

## SECTION XI – TOXICOLOGICAL INFORMATION

---

This mixture has not been evaluated as a whole for health effects. Exposure limits listed below, if any, are based on existing data on the individual components.

---

## SECTION XII – ECOLOGICAL INFORMATION

---

Not easily biodegradable.

No data available on environmental toxicity

---

### SECTION XIII – DISPOSAL CONSIDERATIONS

---

Follow all local and federal regulatory compliance regulations and laws.

---

### SECTION XIV – TRANSPORTATION INFORMATION

---

US DOT Classification: Not regulated for transportation

This product is not regulated as a hazardous material by the U.S. Department of Transportation (DOT). This product is not regulated for air travel by the U.S. Department of Transportation.

---

### SECTION XV – REGULATORY INFORMATION

---

OSHA: N/A

TSCA: All components of this product are listed on or exempt from the TSCA Inventory.

US EPA CERCLA HAZARDOUS SUBSTANCES: N/A

California Prop 65: This compound contains DIDP which is an additive that the state of California considers may cause cancer.

---

### SECTION XVI – OTHER INFORMATION

---

The information provided in the SDS is correct to the best of our knowledge and information as of the publication date. This information is provided as guide for safe handling, storage, transportation and use. It in no way implies any warranties or quality specifications. Users should make an independent determination of the suitability and completeness of the information provided.