



EARTH SHIELD®

Waterstops for Chemical, Industrial, & Environmental Applications



Waterstops play a critical role in the integrity of concrete structures. They provide a fluid-tight diaphragm when embedded in, and running through concrete joints. Earth Shield® Thermoplastic Vulcanizate Waterstop (TPV), by J P Specialties, Inc., dramatically expands the scope of conventional waterstop by offering unmatched chemical resistance to a broad spectrum of aggressive chemicals, solvents, and hot petroleum oils. Manufactured NSF-certified, EPA-compliant waterstop profiles are available for new construction and retrofit, as well as the tools and accessories for proper field installation.

All ribbed Earth Shield® Waterstop profiles are available with factory installed brass eyelets. The eyelets provide for a convenient and durable tie-off point for wire tying the waterstop to the steel reinforcement prior to the concrete pour.

J P Specialties, Inc. is the leading manufacturer of chemical resistant waterstop and related concrete accessories. Our NSF 61 certified Earth Shield® line of chemical resistant waterstop is used throughout the world by major engineering firms and project owners for primary and secondary containment applications, as well as industrial wastewater treatment and ozone contactor structures. We invented the technology used to mechanically weld thermoplastic waterstops.



Earth Shield® Retrofit Column and Pipe Fitting (part number JP320LC1.XX* [*XX is diameter in inches]) is manufactured with a flexible, chemical-resistant polymer and includes all stainless steel anchoring hardware.



Earth Shield® JP636 TPV Ribbed Centerbulb (6" width) is the industry standard, utilized on most jobs for its proven fluid-sealing properties.

Services offered include free blueprint take-off and shop drawings, on-site welding certification, and individual corrosion resistance certification for the project owner.

See page 14 for more info

See page 4 for more info

Earth Shield® Chemical Resistant Waterstop
Phone: 800-821-3859; 951-763-7077
Fax: 951-763-7074

www.earthshield.com



Earth Shield® Thermoplastic Vulcanizate (TPV / TPER) Waterstop Basic Use

Earth Shield® Thermoplastic Vulcanizate Waterstop is used as a fluid-tight diaphragm, embedded in concrete, across and along the joint, for primary and secondary containment structures. Earth Shield® Chemical Resistant Waterstops



are resistant to a wide range of oils, solvents, and aggressive chemicals. Alcohol, ketones, glycols, esters, and aqueous solutions of acids, salts, and bases have little effect on Earth Shield® Thermoplastic Vulcanizate Waterstop.



Unlike polyvinyl chloride (PVC) waterstop, Earth Shield® waterstop contains no plasticizer, stabilizer, or filler to leach out when exposed to chemicals, fuels, and aggressive industrial fluids. Also, unlike PVC waterstop, Earth Shield® can withstand prolonged exposure to high



and low temperatures (-78°F to 275°F long term) without detrimental effect.

Earth Shield® TPV Waterstop is NSF Standard 61 Certified for use in drinking water and is a recyclable polymer, so it's good for health and the environment.

The superior chemical resistance of Earth Shield® Thermoplastic Vulcanizate Waterstop coupled with the use of a ribbed centerbulb configuration, which is available in a 4, 6, and 9-inch width, providing greater mechanical bonding with the concrete and a barrier against migration of liquid flow around the waterstop. The ribbed centerbulb style also allows for joint movement and may be used in above or below grade applications. Additional shapes are available for retrofit, extreme expansion, stainless steel, and base seal applications.

Different varieties and grades of thermoplastic elastomers (TPE) are commercially available. On the low-end, there is a thermoplastic polyolefin (TPO), which has a rubber phase that is not cross-linked. On the high-end, there is thermoplastic vulcanizate (TPV)... Earth Shield® has chosen a fully cross-linked TPV as our standard elastomer compound, which provides superior mechanical properties, retention, and chemical resistance. No competitive product is even close to achieving the physical properties of Earth Shield®.

Typical Applications

- Primary and secondary containment
- Waste water treatment plants
- Refineries
- Ozone contactor structures
- Mining facilities
- Fueling areas
- Chemical factories
- Manure pits



Earth Shield® Advantages

- Outstanding fluid resistance to a wide range of aqueous-based fluids, oils, and hydrocarbons
- Excellent retention of physical properties at elevated temperatures
- Superior ozone and weather resistance

Installation

Install Earth Shield® TPV Waterstop in all concrete joints. Waterstop should be centered in, and run the extent of the joint. All changes of di-



pH Range

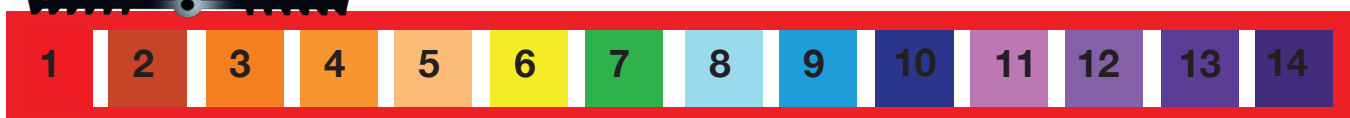

rections should be prefabricated (see Shop Made Fittings), leaving only butt-welding for the field. If installing in an expansion joint, keep center bulb unembedded to allow it to accommodate movement as designed. Use optional factory installed brass eyelets (or #3 hog rings) and tie wire to secure waterstop to reinforcing steel to avoid displacement during the concrete pour. Splice straight lengths of waterstop and Shop Made Fittings to straight lengths, with an ST-10® In-Line Waterstop Splicer with the iron temperature set to 410°F to 430°F. More detailed installation instructions are in our Standard 3-part Specifications.

Technical Assistance

Qualified technical assistance is available during any phase of your construction project.

Specifications

Standard 3-part Specifications are available at our website in Microsoft® Word and Adobe® PDF format, and upon request in printed and a variety of computer word processor formats. Call our Technical Sales Staff for additional help with your specification.

Suggested Proprietary Short Form Guide Specification Section 03150 (Master Format 2004 – 03 15 13)

TPV Chemical Resistant Waterstop

Waterstop indicated in drawings and specifications for contraction (control), expansion and construction joints shall be Earth Shield® TPV Chemical Resistant Waterstop Part No. #####

[Designer insert appropriate part number here] as manufactured by J P Specialties, Inc.; Murrieta, CA 92562; Phone 951-763-7077

1. Thermoplastic Vulcanizate (TPV) Waterstop shall conform to EPA Title 40 CFR Section 265.193. The suitability of the waterstop for a specific application should be determined by specific testing for that particular requirement per ASTM D471. Project-specific certification to be provided by the manufacturer.
2. Thermoplastic Vulcanizate (TPV) Waterstop shall be independently certified for use in potable water per NSF/ANSI Standard 61. Third-party certified documentation to be provided by the manufacturer.
3. No equals or substitutions allowed.



Property	Test Method	Required Results
Specific Gravity	ASTM D792	.96
Shore A Hardness (5 sec.)	ASTM D2240	90±3 at 25°C (77°F)
Tensile Strength	ASTM D412	2,300 psi
Ultimate Elongation	ASTM D412	530%
100% Modulus	ASTM D746	1,000 psi
Tear Strength	ASTM D624	278 pli at 25°C (77°F)
Compression Set	ASTM D395	29% at 25°C (77°F)
Brittle Point	ASTM D746	-61°C (-78°F)
Drinking Water Safe	NSF/ANSI 61 	Waterstop certified by NSF for use in potable water
Ozone Resistance	ASTM D1171	Passed, no cracking at 600 pphm
Chemical Resistance	ASTM D471	Meet or exceed specific testing standards for contained fluids as required by Owner and certified by Manufacturer
Green Certification	GreenSpec	Approved

Earth Shield® TPV Waterstop (part no. JP636)  NSF 61 Certified WWW.EARTHSHIELD.COM 888-836-5778 05 304 101

Ribbed Centerbulb for Moving and Non-Moving Joints

Ribbed centerbulb is the most versatile type of waterstop available. The centerbulb accommodates lateral, transverse, and shear movement. Ribbed centerbulb waterstops function in expansion, construction, and control joints.

They also provide superior anchoring abilities and a long fluid-flow path because of the multiple ribs on the exterior flanges. Under stress, the many ribs will distort less than a dumbbell type waterstop because the pressure is first applied to the inward-most anchoring rib, and decrease to the subsequent ribs.

The centerbulb allows for joint movement beyond the ultimate elongation of the material, without distorting the anchoring ribs. All of our ribbed centerbulb waterstops have large outer diameter centerbulb. This centerbulb, coupled with the outstanding mechanical properties of our elastomers (ultimate elongation, tensile strength, etc.), provides for unsurpassed joint movement and sealing abilities.

Like all our thermoplastic waterstops, Earth Shield® ribbed centerbulb waterstop can be

heat-welded using a standard waterstop splicing iron, allowing for easy field fabrications and allows the waterstop to function as a continuous, homogeneous, fluid-tight diaphragm. Waterstop directional changes are available along with straight roll stock. Custom, fit-to-print waterstop modules are produced to order. Prefabricated ells, tees, tank pads, column fittings, and many others are in stock and ready to ship.

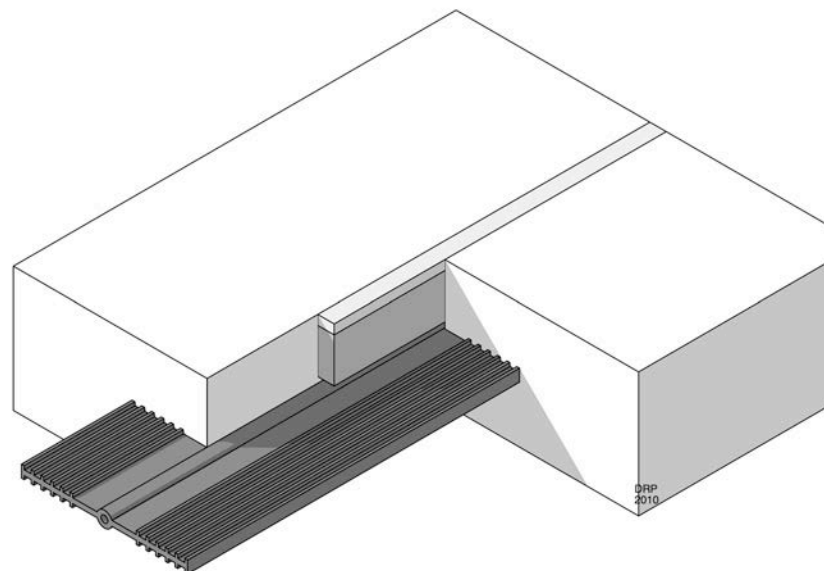

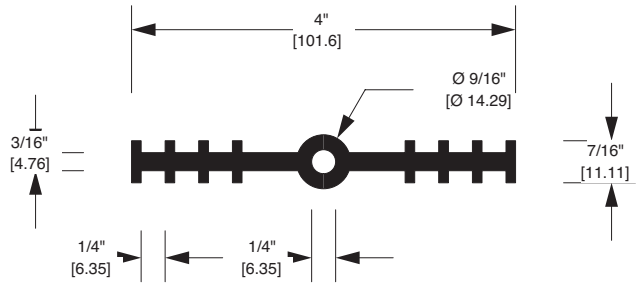

JP436 (with eyelets: EYJP436)
4" Ribbed Centerbulb Waterstop
 75 ft Head of H₂O • 50 lft/roll

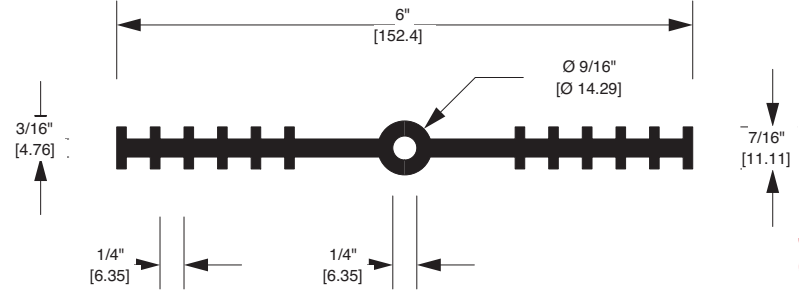

JP636 (with eyelets: EYJP636)
6" Ribbed Centerbulb Waterstop
 125 ft Head of H₂O • 50 lft/roll

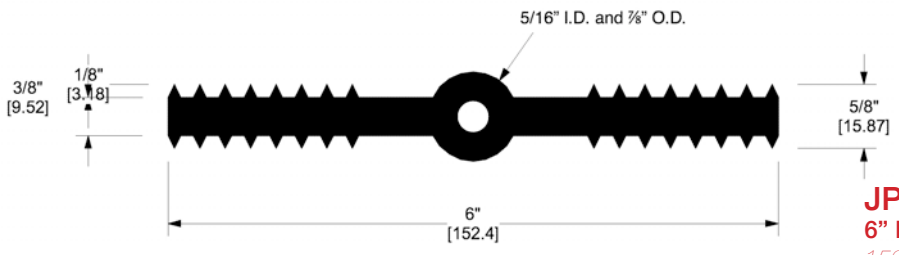

JP638 (with eyelets: EYJP638)
6" Ribbed Centerbulb Waterstop
 150 ft Head of H₂O • 50 lft/roll

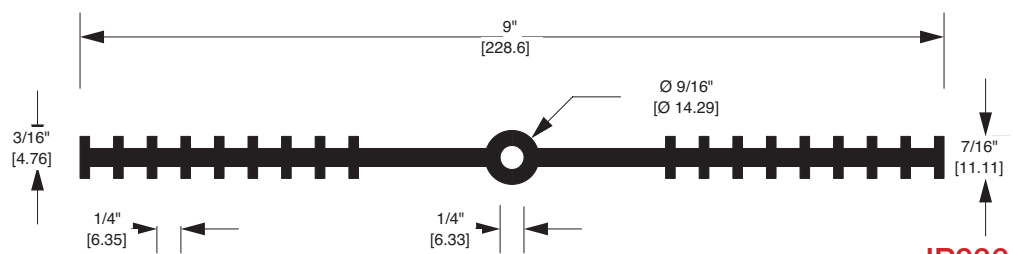

JP936 (with eyelets: EYJP936)
9" Ribbed Centerbulb Waterstop
 175 ft Head of H₂O • 50 lft/roll

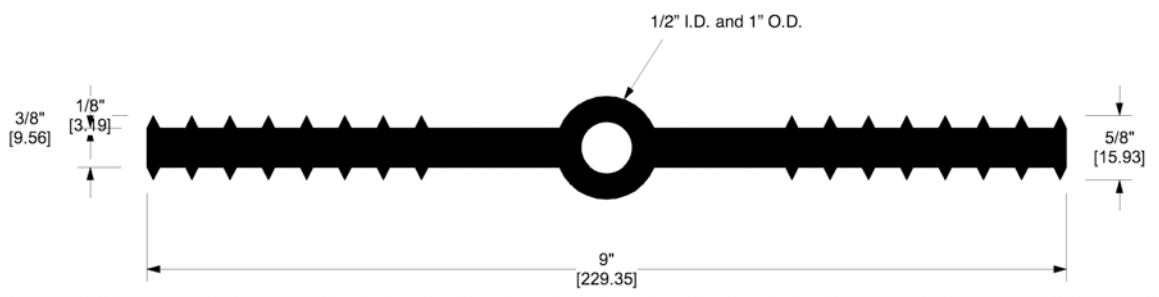

JP938 (with eyelets: EYJP938)
9" Ribbed Centerbulb Waterstop
 200 ft Head of H₂O • 50 lft/roll

Retrofit Waterstop Systems

for New to Existing Concrete Joints

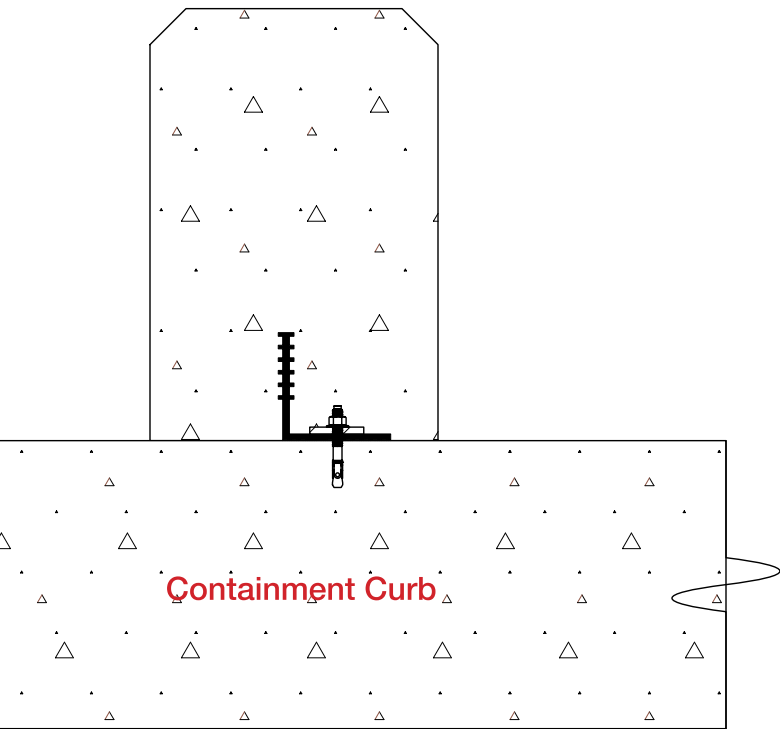

Retrofit waterstop is designed to provide a fluid-tight seal between existing and new concrete construction, without resorting to the labor-intensive and structurally destructive saw-cut-and-grout method. It is ideal for constructing a new containment curb or wall to an existing slab or joining a new slab to an existing wall. Special profile fabrications are available for columns and pipe penetrations.

All of our retrofit waterstops are sold as a complete system and include all the necessary stainless steel bars and bolts. We also offer a high-quality chemical resistant novolac epoxy — VEN 1000.

Like all our thermoplastic waterstops, Earth Shield® retrofit waterstop can be heat-welded using a standard waterstop splicing iron, allowing for easy field fabrications, and enable the waterstop to function as a continuous, homogeneous, fluid-

tight diaphragm. Waterstop change of directions can be available along with straight roll stock, and custom, fit-to-print waterstop modules are produced to order. Prefabricated ells, tees, tank pads, column fittings, and many others are in stock and ready to ship.

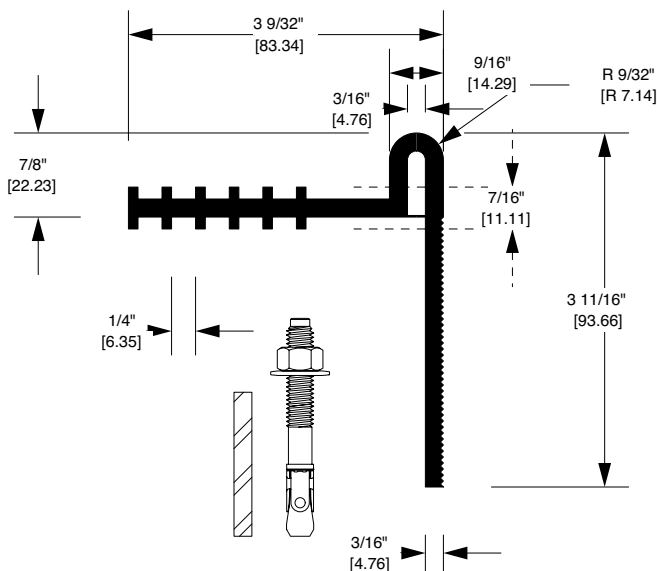

JP320L (with eyelets: EYJP320L)
Retrofit Waterstop System
(Includes all batten bars and anchors)
 125 ft Head of H₂O • 10 lft/length

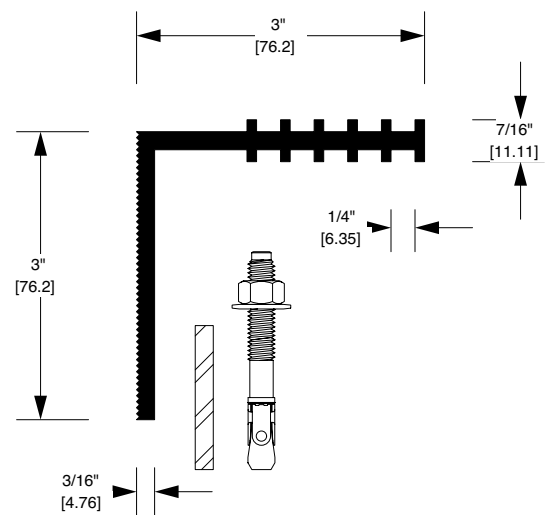

JP336L (with eyelets: EYJP336L)
Retrofit Waterstop System
(Includes all batten bars and anchors)
 125 ft Head of H₂O • 10 lft/length

JP540L
Exterior Applied Corner Retrofit Waterstop
(Includes all batten bars and anchors)
 50 ft Head of H₂O • 10 lft/length

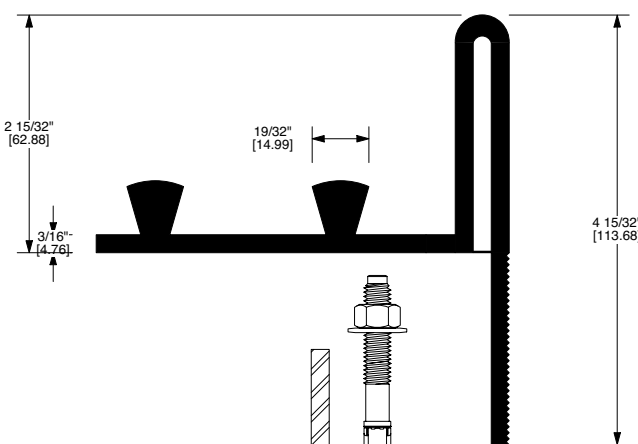
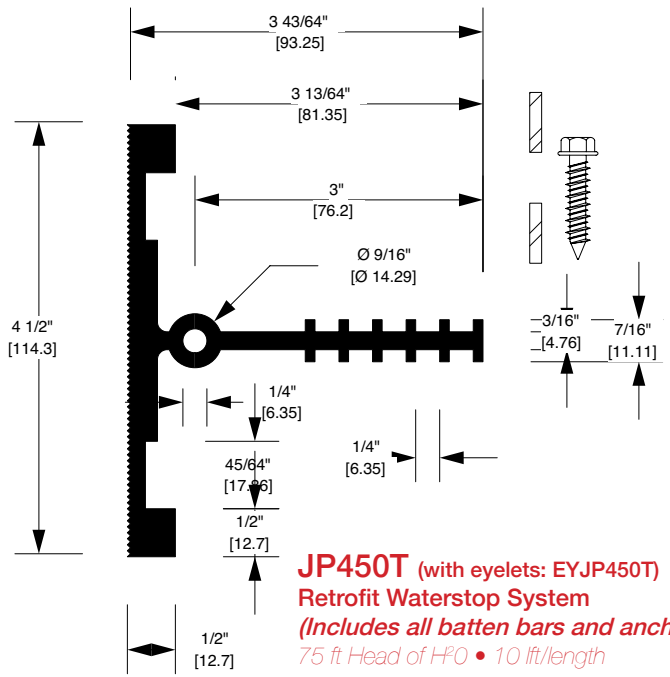
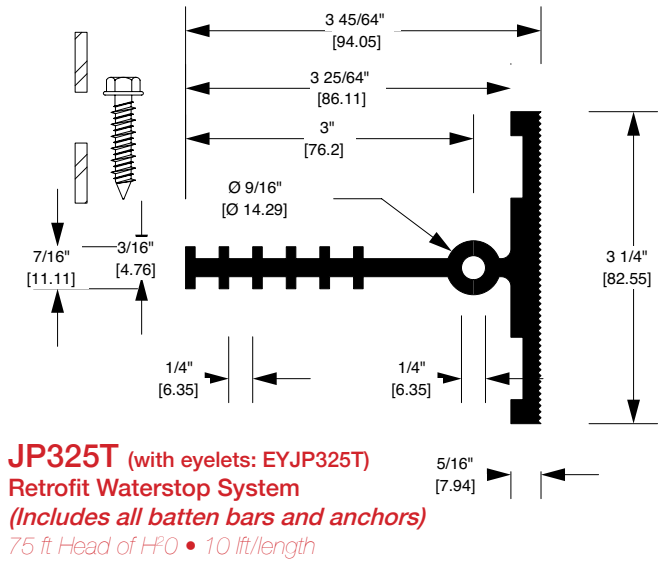
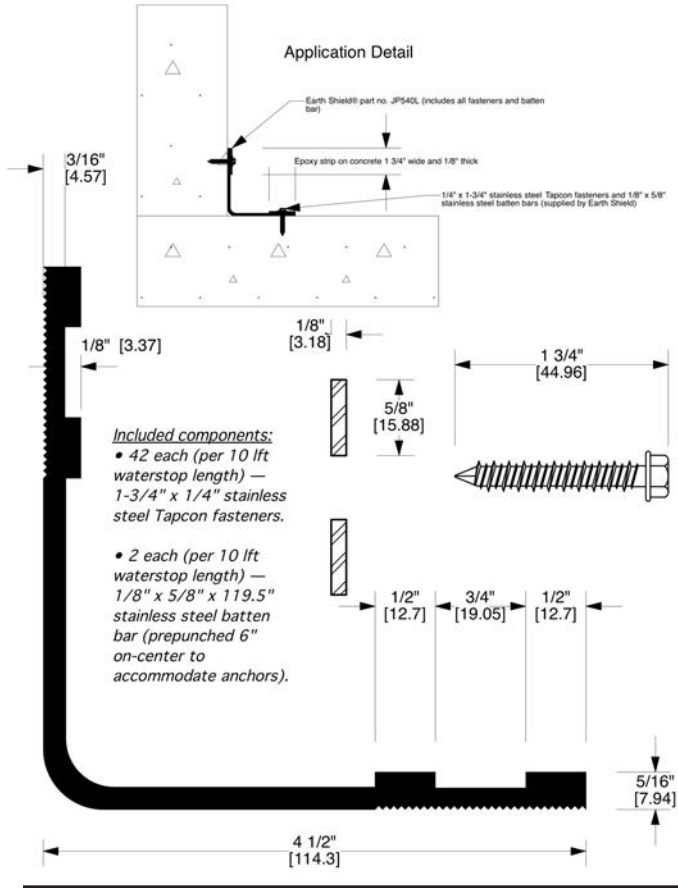

JP621L
Large Movement Retrofit
(Includes all batten bars and anchors)
 75 ft Head of H₂O • 10 lft/length

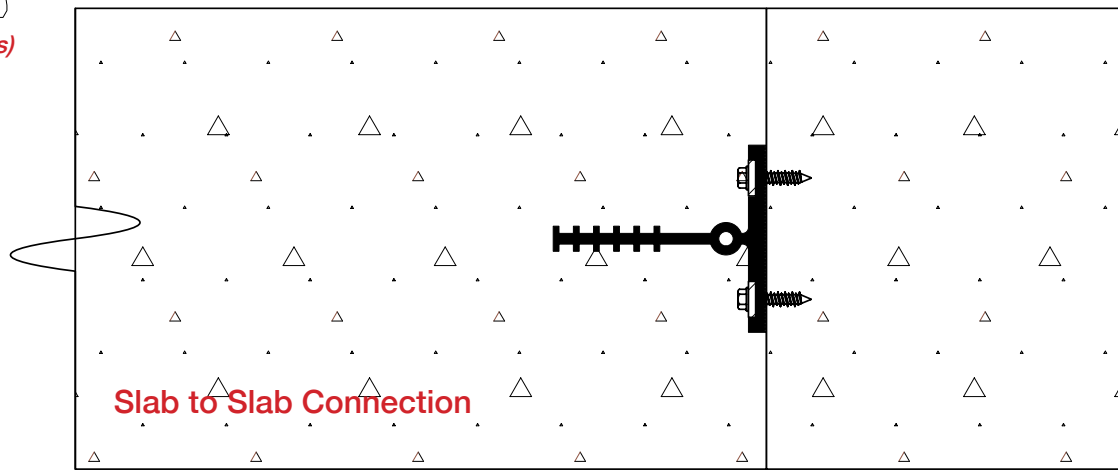

Integrated Cap Systems

Integrated Waterstop and Joint Sealant

Integrated expansion board cap waterstop systems are designed to replace post-applied joint sealant, and provide a fluid-tight internal seal like a traditional waterstop with a one-step, integrated unit.

Install Earth Shield® expansion board cap waterstop on top of conventional expansion board filler or Earth Shield's chemical resistant, plastic expansion board. The expansion board acts as the form; therefore, no form splitting is necessary, significantly accelerating the project schedule and provides a long-lasting, attractive finished concrete joint.

- No split forms
- Accelerated installation
- No sawcutting or sealant
- No joint finishing
- Long life
- UV and abrasion resistant

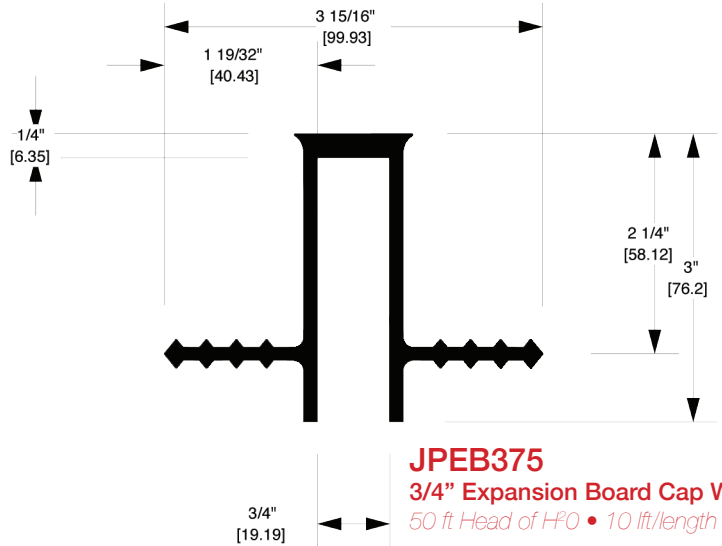

JPEB375
3/4" Expansion Board Cap Waterstop
 50 ft Head of H₂O • 10 ft/length

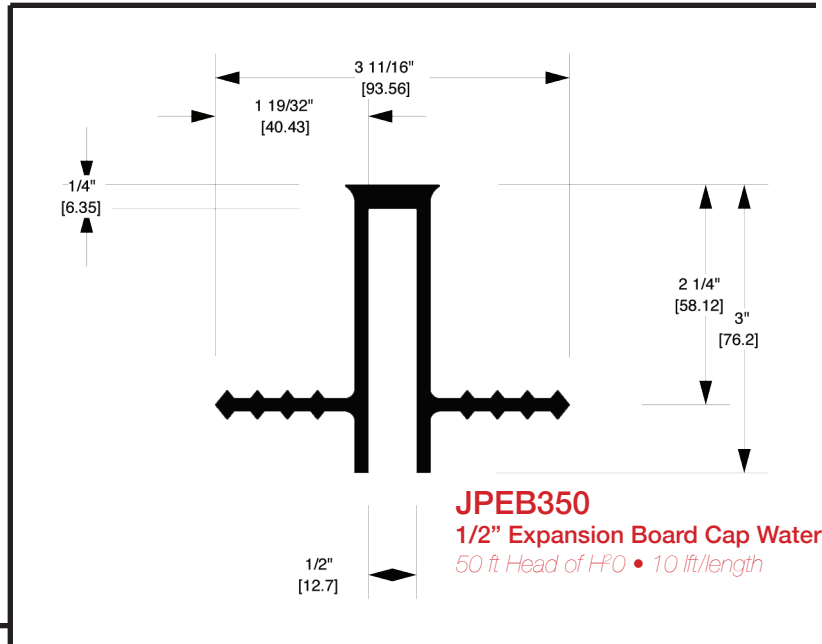

JPEB350
1/2" Expansion Board Cap Waterstop
 50 ft Head of H₂O • 10 ft/length

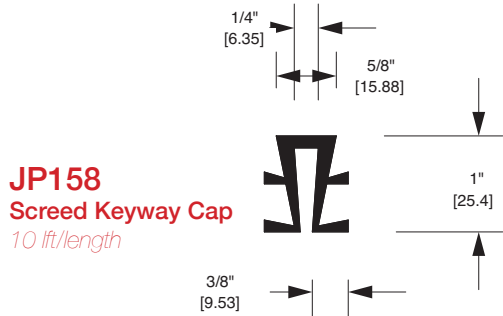

JP158
Screenshot Keyway Cap
 10 ft/length

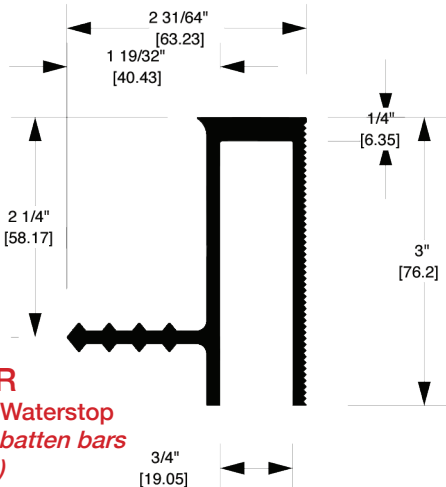

JPEB375R
Cap Retrofit Waterstop
 (Includes all batten bars and anchors)
 50 ft Head of H₂O
 10 ft/length

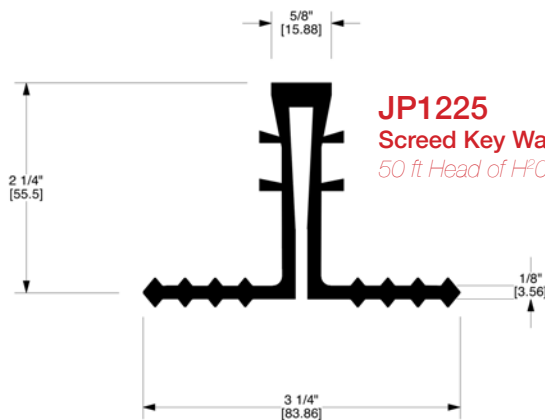

JP1225
Screenshot Key Waterstop
 50 ft Head of H₂O • 10 ft/length

Corner Seal

Unique Problem-Solver, Integrates with Base Seal

Corner seal waterstop systems install on the footer at a slab/wall interface. Earth Shield® corner seal works well with our base seal profile (JP211).

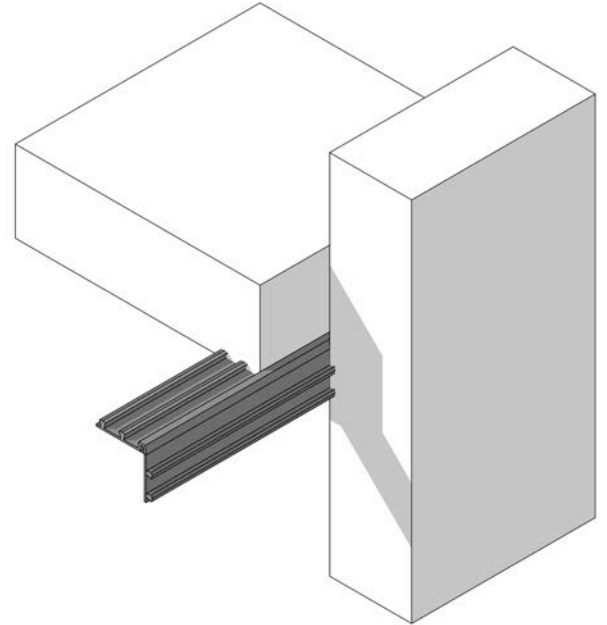
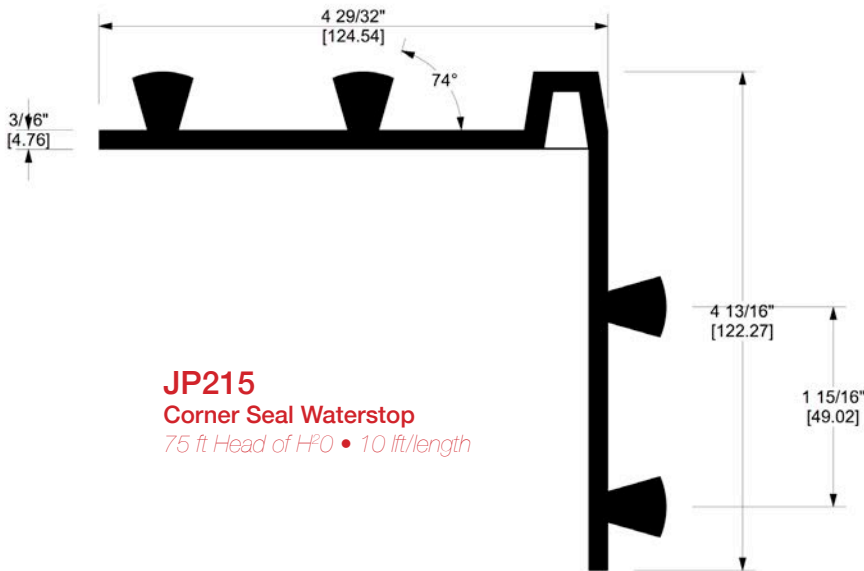

Flat Strip (aka Ribbed)

Resists High Head Pressure

Flat strip waterstop is installed most often in below grade applications, with limited movement. Flat strip waterstop functions in construction and contraction (control) joints.

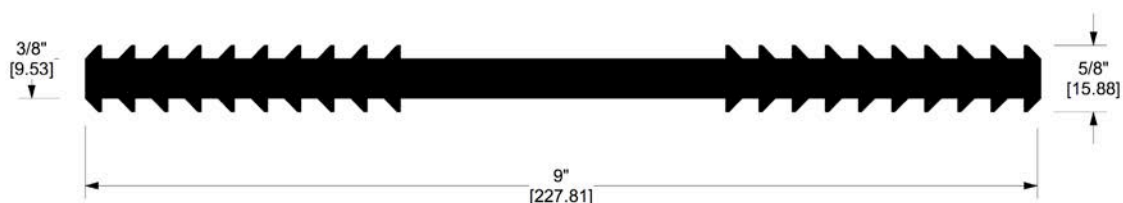
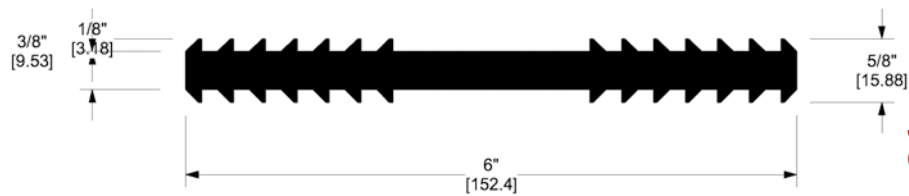

Made in t

Waterstop for Che & Environments

Manufactured
with pride by



J P SPECIALTIES, INC.

www

the U.S.A.

J P Specialties, Inc. manufactures a wide range of high-quality waterstop and waterstop accessories for the concrete construction industry. Our Earth Shield® line of chemical resistant waterstop is designed to offer solutions for today's unique regulatory compliance needs. Our waterstop welding equipment is used industry-wide as the standard for quality, high tensile strength waterstop welds. Knowing that a waterstop will only offer a fluid-tight barrier if change of directions are done properly, J P Specialties has been a leader since 1954 in Prefabricated Waterstop Modules and Shop Made Fittings.

Chemical, Industrial, and Residential Applications

WWW.EARTHSHIELD.COM

Special Shapes

for Large Movement Joints

Earth Shield® tear web waterstops are for large joint movements such as tank foundations. Tear web is suitable for expansion joints. For construction and contraction (control) joints, install ribbed centerbulb instead.

JP678 (with eyelets: EYJP678)
6" Tear Web Waterstop
 125 ft Head of H₂O • 50 lft/roll

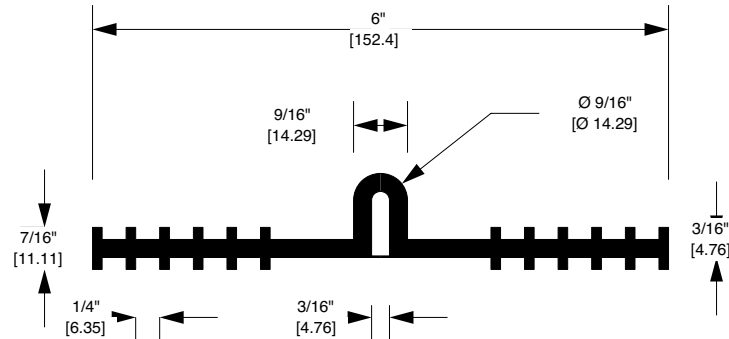

JP978 (with eyelets: EYJP978)
9" Tear Web Waterstop
 175 ft Head of H₂O • 50 lft/roll

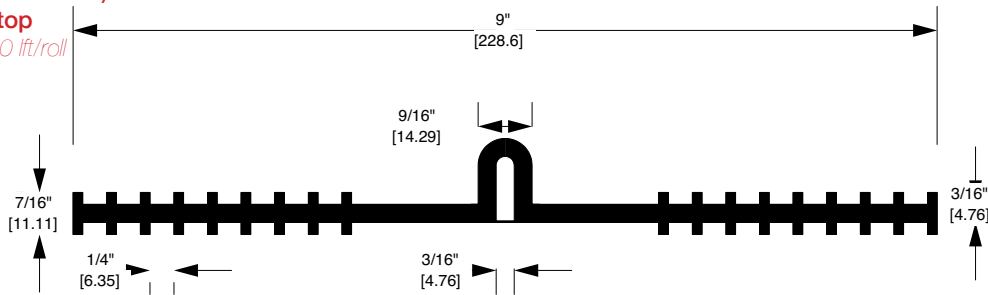

Base Seal (aka Rearguard)

for Flatwork and Bund Wall Applications

Base seal waterstop is ideal for flat pavement jobs such as runways and large containment slabs. Base seal waterstop is by far the easiest waterstop to install... Simply lay the waterstop directly on the compacted subgrade, place and finish concrete, and create control joint using a saw cut or another method. The base seal provides a permanent, life-of-structure seal at the bottom of the joint. Base seal is suitable for construction, contraction (control), and expansion joints. For sizeable hydrostatic head pressures (>50 foot) ribbed centerbulb should be used instead.

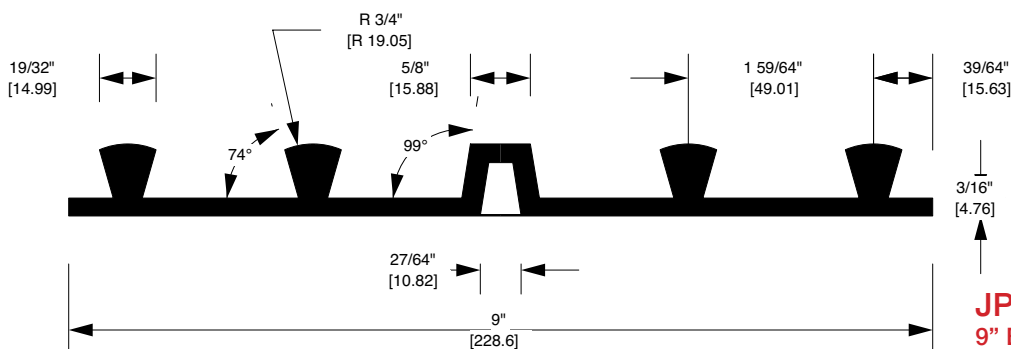

JP211
9" Base Seal Waterstop
 75 ft Head of H₂O • 50 lft/roll

Dumbbell

Large Web Thickness for Heavy Concrete

Dumbbell waterstop is installed most often in below grade applications, with limited movement. Dumbbell waterstop works well in construction and contraction (control) joints; whereas, dumbbell centerbulb accommodates construction, control, and expansion joints.

The large centerbulb (1-1/2" outer diameter) on the JP949 (and JP1149) waterstop profile, coupled with the outstanding mechanical properties of our thermoplastic elastomers and large endbulb anchors, enable the product to withstand large-scale joint movement (seismic or settlement).

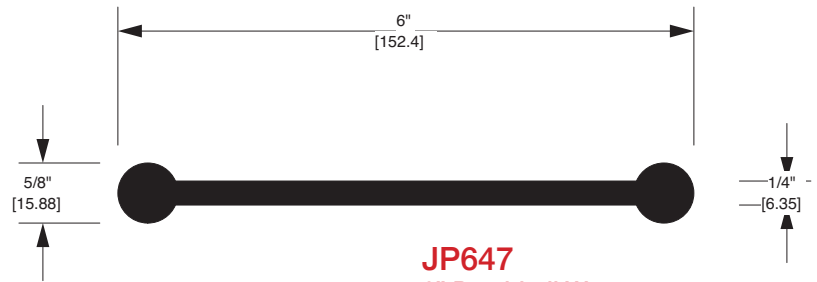

JP647
6" Dumbbell Waterstop
 125 ft Head of H₂O • 50 lft/roll

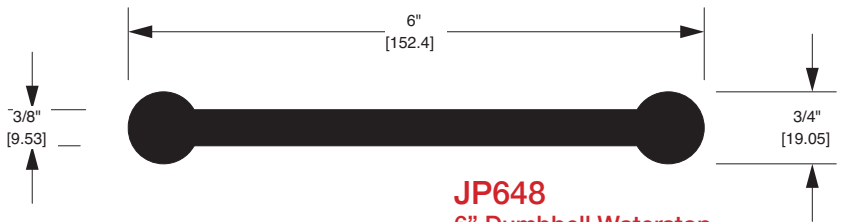

JP648
6" Dumbbell Waterstop
 125 ft Head of H₂O • 50 lft/roll

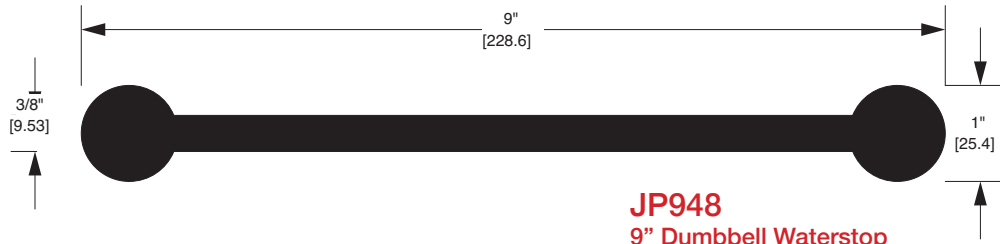

JP948
9" Dumbbell Waterstop
 150 ft Head of H₂O • 50 lft/roll

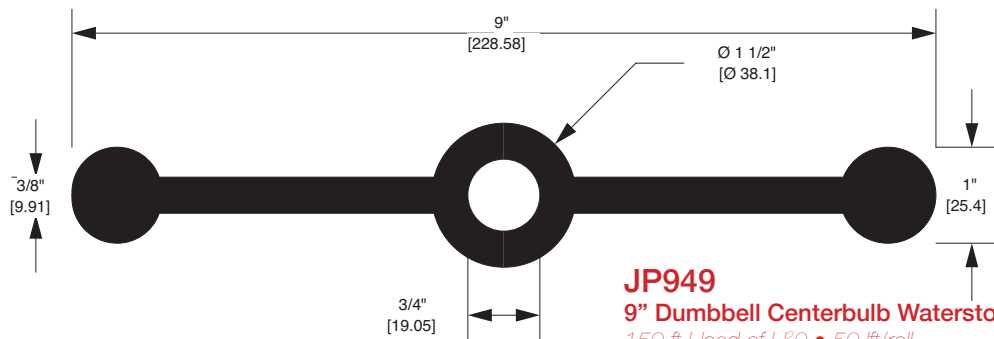

JP949
9" Dumbbell Centerbulb Waterstop
 150 ft Head of H₂O • 50 lft/roll

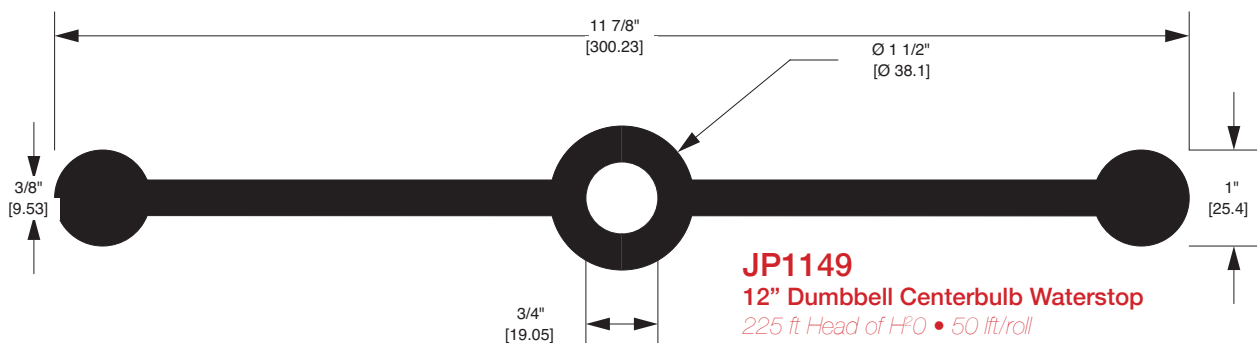

JP1149
12" Dumbbell Centerbulb Waterstop
 225 ft Head of H₂O • 50 lft/roll

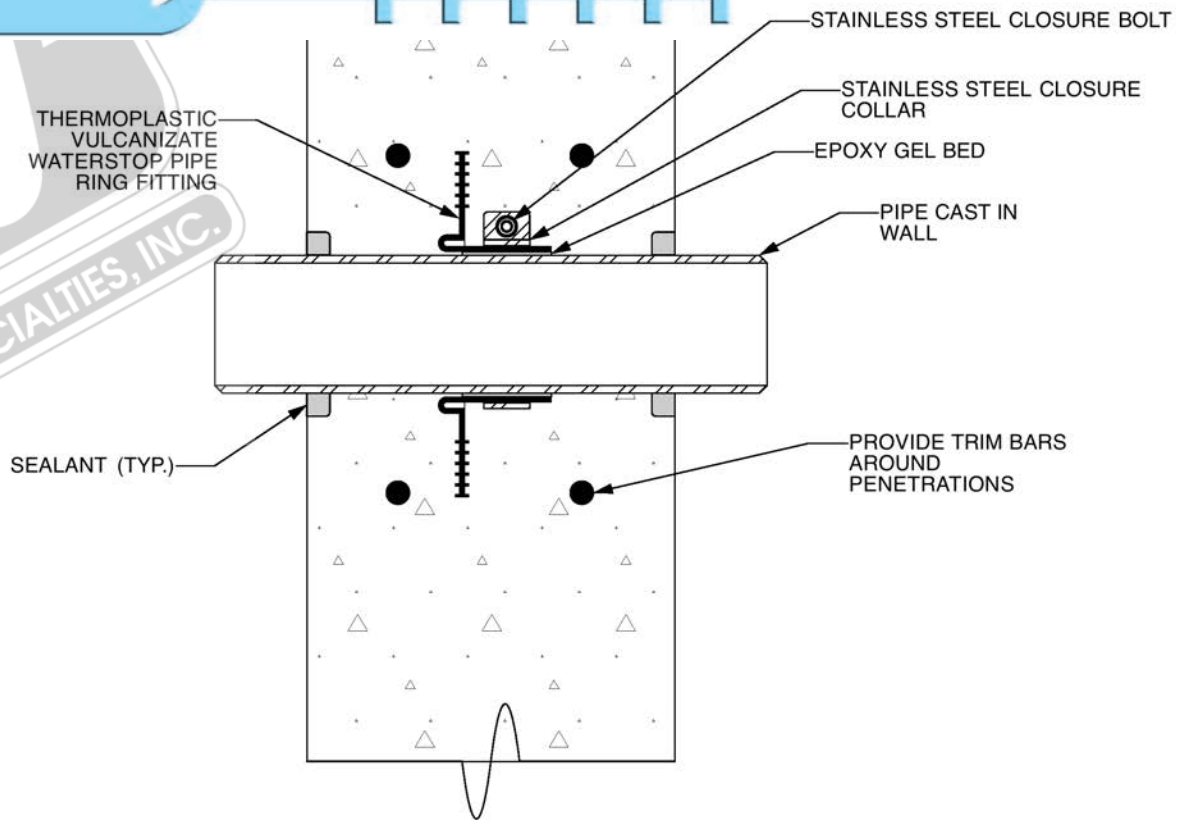

JP Specialties, Inc. / Earth Shield® 551 Birch Street • Lake Elsinore, CA 92530 • www.jp-specialties.com phone 800-821-3859 • international 951-674-6869 • fax 951-674-1315		
TITLE Waterstop Pipe Fitting		
PART NUMBER JP320LC1	DRAWN BY DRP	DATE 11/09
CAD FILE NAME ACI350_2R_Waterstop_Collar	APPROVALS	SIZE A

Retrofit Column and Pipe Fitting

Earth Shield® has solved a long-standing problem for engineered concrete structures with circular protrusions, such as columns, pipes, piers, and pilasters. The problem: how to permanently seal the concrete joint when cast-in-place concrete is formed against an existing circular member. The solution: Earth Shield® Column & Pipe Fitting (part no. JP320LC1.XX* [*XX is the diameter in inches]) manufactured with a flexible, chemical-resistant polymer and stainless steel anchoring hardware. A single laborer on the job site can quickly install the column fitting and its associated hardware. Just apply an epoxy gel bed to the existing surface; place the polymer ring into the epoxy gel bed; heat weld the single opening on the polymer ring using a waterstop splicing iron; and finally, complete the system with the stainless steel closure ring.

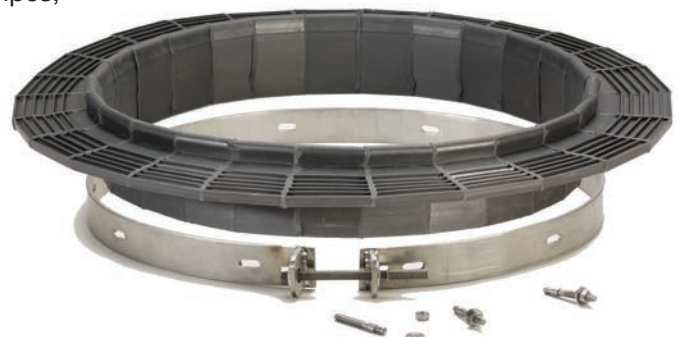

The Earth Shield® system functions as an internal dam, centrally located within the cast concrete, to stop aggressive chemicals, solvents, and hot petroleum oils from penetrating the joint. By preventing the passage of hazardous liquids, the Earth Shield® Column Fitting provides facility owners, engineers, and contractors with the necessary EPA-mandated containment compliance (EPA Title 40 CFR 265.193). Of course, the system prevents the passage of water as well. The mechanical properties of the polymer, plus the tear-web design of the JP320L profile, enable the column fitting to function equally well in expansion (isolation) joints and construction joints.

Standard Fabrications

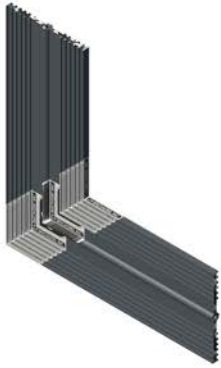

JP436L1 Flat Eil
JP636L1 Flat Eil
JP936L1 Flat Eil



JP436T1 Flat Tee
JP636T1 Flat Tee
JP936T1 Flat Tee



JP436X1 Flat Cross
JP636X1 Flat Cross
JP936X1 Flat Cross



JP436L2 Vert Eil
JP636L2 Vert Eil
JP936L2 Vert Eil



JP436T2 Vert Tee
JP636T2 Vert Tee
JP936T2 Vert Tee



JP436X2 Vert Cross
JP636X2 Vert Cross
JP936X2 Vert Cross



JPEB350X1 Flat Cross
JPEB375X1 Flat Cross
JP1225X1 Flat Cross



JPEB350T1 Flat Tee
JPEB375T1 Flat Tee
JP1225T1 Flat Tee



JPEB350L1 Flat Eil
JPEB375L1 Flat Eil
JP1225L1 Flat Eil



JPEB350L2 Inside Corner
JPEB375L2 Inside Corner
JP1225L2 Inside Corner



JPEB350L3 Outside Corner
JPEB375L3 Outside Corner
JP1225L3 Outside Corner

*Many other
standard fittings
are available*



J P SPECIALTIES, INC.

Base/Corner Seal

- JP211
- JP621L
- JP215

Flat Strip

- JP637
- JP937

Retrofit

- JP320L
- JP325T
- JP336L
- JP450T
- JP500
- JP540L
- JP621L
- JPEB375R

Ribbed Centerbulb

- JP436
- JP636
- JP638
- JP936
- JP938

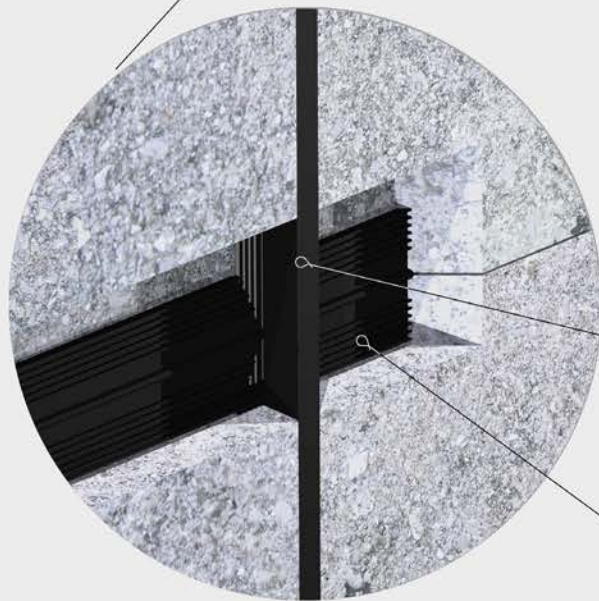

[EXPANSION JOINT]

JP636
[6" RCB TPV WATERSTOP]

[9" BASE]

TYPICAL TRENCH EXPANSION JOINT

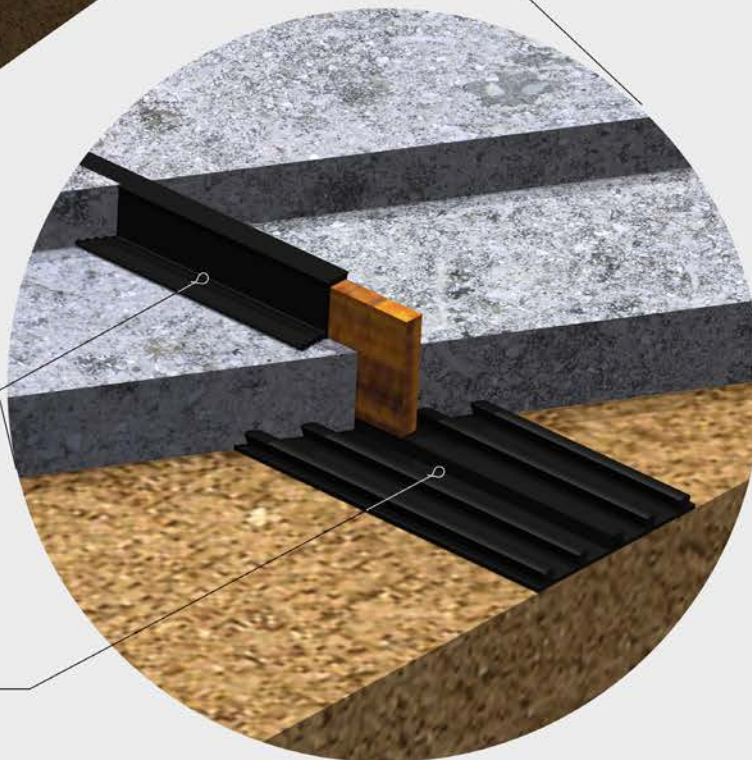

JPEB375
[ANT WATERSTOP]

JP211
[SEAL TPV WATERSTOP]

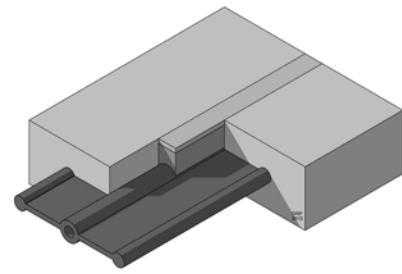

Dumbbell
 JP647
 JP648
 JP948
 JP949
 JP1149

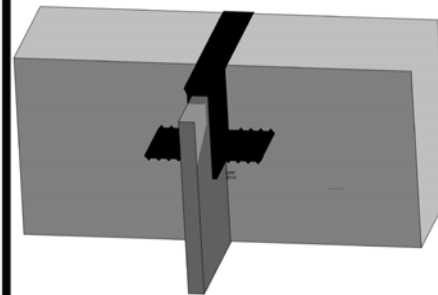

Integrated Cap
 JP158
 JPEB350
 JPEB375
 JPEB375R
 JP1225

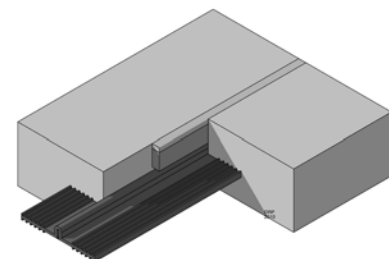

Tear Web
 JP678
 JP978

Waterstop Shop Made Fittings

Ensure A Quality, Leak-Proof Project

Shop Made Fittings are recognized and specified worldwide by major engineering firms. The U.S. Army Corps of Engineers also specified Shop Made Fittings in the July 1995 revision of CEGS Section 03250. Shop Made Fittings are specified because they work. Edge-welding waterstop severely compromises the integrity of any project. Even the limited movement of concrete during the coefficient of expansion and contraction can be too much for edge welded waterstop. The edge welded waterstop lacks the proper tensile strength and does not maintain the characteristics of the parent material (bulb or rib continuity). Consequently, the waterstop often tears at the most critical junction: the change of direction. Since all waterstops are designed to act as a continuous, fluid-tight diaphragm which fluids (generally water) traverse, the structure that uses edge welded waterstop will naturally leak, as fluids migrate to any tears in the weld and pass through to the other side of the joint.

Structures that use Shop Made Fittings will significantly reduce these waterstop failures. The tensile strength of the weld will be at least 80% of the parent material, maintaining the continuity of the bulbs and ribs across the weld. In other words, the waterstop will perform as intended and last the life of the structure.

J P Specialties has an extensive library of CAD drawings that illustrate the many uses of various Shop Made Fittings and explain waterstop's role in creating a fluid-tight structure.

J P Specialties certified welding crew efficiently manufactures large quantities of top-quality Shop Made Fittings with speed on our exclusive XLT-2000 Waterstop Splicing Tables. Therefore, we can pass the savings on to the end user: the contractor. Besides saving money, the contractor who uses Shop Made Fittings will save time. A standard flat cross has twelve cuts and seven welds. By using Shop Made Fittings, all of the cuts and three of the welds are eliminated. The number of welds is further reduced by using modules.

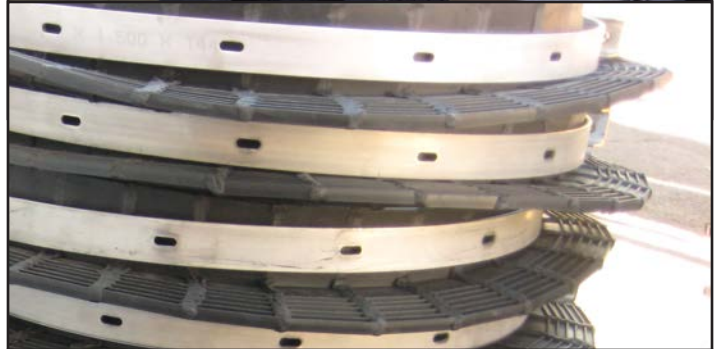



NSF/ANSI Standard 61 was developed to establish minimum requirements for the chemical contaminants and impurities imparted to drinking water from products, components, and materials used in drinking water systems.

Standard 61 is intended to cover specific materials or products that come into contact with drinking water, drinking water treatment chemicals, or both. The focus of Standard 61 is the evaluation of contaminants or impurities imparted indirectly to drinking water.

In the U.S., 47 of 50 states have legislation that requires compliance with NSF/ANSI Standard 61. Products that are NSF Certified against NSF/ANSI Standard 61 demonstrate compliance with both Canadian and U.S. Plumbing Codes. NSF Certification and Testing are widely accepted. NSF data is recognized by ASSE, BOCA, IAPMO, ICBO-ES, SBCCI, the City of Los Angeles and many others.

Trust Your Critical Water Projects to Earth Shield® — NSF Standard 61 Certified, EPA Compliant Waterstop

Water is arguably the most valuable resource in the world. Today's water treatment, distribution, and storage projects are under ever-increasing layers of regulations and requirements, the foremost being that components and materials that contact potable water not have potential adverse human effects.

Earth Shield® TPV Waterstop, with NSF 61 certification, is the perfect choice for today's critical water projects, and in particular drinking water projects.

Page 1 of 2
Issue Date 1-OCT-03

NSF International (NSF)
DRINKING WATER ADDITIVES AUTHORIZED REGISTERED FORMULATION
AUTHORIZED REGISTERED FORMULATION - STANDARD 61
TOXICOLOGY INFORMATION SHEET

REVISED Revised function and listing footnote

DCC: IA12497
Verified By: *Jennifer Durham (1455)*

Corp. No. 1D630
Plant No. 1D631

Company Name JP SPECIALTIES, INC. / EARTH SHIELD WATER
Plant Address 551 BIRCH STREET
LAKE ELSINORE CA 92530

Category: JOINING AND SEALING MATERIALS
Function: Waterstop

Trade Designation
Earth Shield Waterstop
JP158
JP211
JP320L
JP336L
JP325T
JP450T
JP436
JP636
JP647
JP936
JP949
JP678
JP1149
JP948
JP648

Water Contact Temp. CLD 23
Water Contact Material and Code TPE

Listing Footnotes:
This material is approved as a waterstop for use in any potable water treatment or retaining structure.

NSF Certified Waterstop
Independently Tested by NSF International

Availability

National and International Warehouses

Earth Shield® Chemical Resistant Waterstop is readily available from a variety of sources:

- **Preferred Regional Stocking Partners** — *We are partners with some of the very best Concrete Accessories Distributors in the world. All our preferred partners have large stocking inventories and are factory trained to provide the utmost in on-site assistance.*
- **Distributor Sales** — *Earth Shield® can be special ordered from many distributor sales channels throughout the world.*
- **Factory Direct** — *Earth Shield® may be contacted directly for project quotation and product purchase (call 800-821-3859).*

Services

- *Project and Product Certification* — *We assist the Design Engineer and Project Owner with individual project and product certification. When you specify our waterstop, you can be assured it is the correct product for your application.*
- *Take-off Assistance* — *For the Contractor.*
- *Shop Drawings* — *3-D isometric and 2-D CAD details are available to assist the project.*
- *On-site waterstop welding certification class* — *\$500.00 flat fee*
- *On-site waterstop installation assistance* — *\$1,000.00 per day*
- *Telephone and Web-based assistance* — *Always FREE*

Distributed by:

Earth Shield® Chemical Resistant Waterstop
Phone: 800-821-3859; 951-763-7077
Fax: 951-763-7074

www.earthshield.com



 www.facebook.com/waterstop

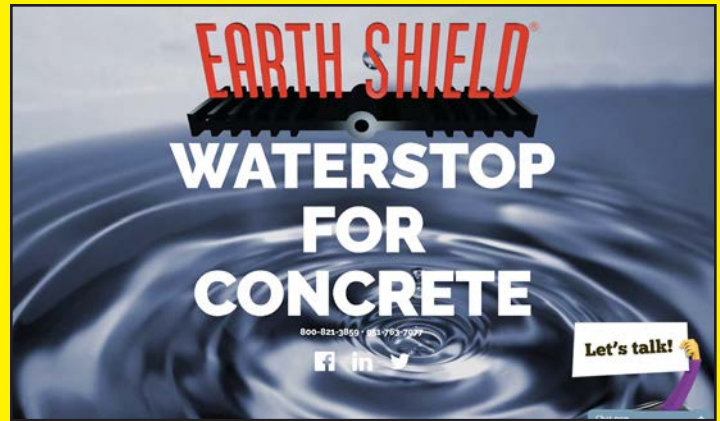

Visit Earth Shield® on the Web at
www.earthshield.com

Earth Shield® Waterstop Limited Warranty

J P Specialties, Inc. warrants to the Buyer that this product is new and will be free from defects and will perform as represented in writing subject to the two (2) following conditions: First, the application of the product and the concrete construction practices used in the application are in accordance with J P Specialties, Inc. recommendations; and, Second, the Buyer has selected the proper product for the specific application required.

Any information supplied in good faith by J P Specialties, Inc. with respect to its products is believed to be correct. J P Specialties, Inc. Makes no representation or warranties, expressed or implied, as to the accuracy or completeness of such information.

The exclusive remedies of the Buyer and the limit of the liability of J P Specialties, Inc. from any and all losses or damages resulting from the use of this product shall be either full refund of the purchase price to the Buyer of this product or the replacement of the quantity of product purchased by the Buyer at the discretion of J P Specialties, Inc.

All supplied testing data has been performed by independent testing laboratories.

SECTION 03150 — WATERSTOPS FOR CONCRETE JOINTS — rev. 03/03/18

***** MasterFormat™ 2004 — Section 03 15 13 *****

Note to Designer: Earth Shield® Chemical Resistant Waterstop is manufactured from proprietary compounds and fully-crosslinked polymers. It is strongly suggested that you specify Earth Shield® as a sole source. There are no equals.

This specification is available in a variety of computer formats on CD-ROM or DVD. Contact Earth Shield® Technical Sales for more information. It can also be found on the web at www.earthshield.com.

Suggested Short Form Guide Specification

Chemical Resistant TPV Waterstop for Concrete Joints

Waterstop indicated in drawings and specifications for contraction (control), expansion, and construction joints shall be Earth Shield® Thermoplastic Vulcanizate (TPV) **Part No. ####** [Designer insert appropriate part number here] as manufactured and available from J P Specialties, Inc. — Murrieta, CA, USA 92562 — Phone 800-821-3859; 951-763-7077; Fax 951-763-7074; www.earthshield.com; E-mail davidp@earthshield.com

1. *Thermoplastic Vulcanizate (TPV) Waterstop shall be certified for use in potable water per NSF/ANSI Standard 61. Third-party certified documentation to be provided by manufacturer.*
2. *No equals or substitutions allowed.*

TPV Waterstop Shop Made Fittings for Directional Changes

Intersection and change of direction waterstops shall be factory fabricated as manufactured and available from J P Specialties, Inc. — Murrieta, CA, USA 92562 — Phone 800-821-3859; 951-763-7077; Fax 951-763-7074; Web www.earthshield.com; E-mail davidp@earthshield.com and installed at all locations on the drawing by the Contractor. The Contractor shall only weld straight lengths of waterstop with all change of directions (fittings) being fabricated and supplied by Manufacturer.

1. *No equals or substitutions allowed.*

Suggested Long Form Guide Specification

PART 1 GENERAL

1. Provision Includes

- A. Embedded waterstop in concrete including contraction, expansion and construction joints creating a continuous diaphragm to prevent the passage of fluid.
- B. The use of nonmetallic waterstops for use in concrete joints subjected to chlorinated water, sea water, oils, solvents, acids, salts, fuels and many other aggressive chemicals and fluids.

1. References

The publications listed below form a part of this specification to the extent referenced. The publications are referred to in the text by basic designation only.

- A. American Society for Testing and Materials (ASTM)
 1. ASTM D 395 — Test Methods for Rubber Property — Compression Set.
 2. ASTM D 412 — Test Methods for Vulcanized Rubber and Thermoplastic Rubbers and Thermoplastic Elastomers — Tension.
 3. ASTM D 471 — Test Method for Rubber Properties — Effects of Chemicals.
 4. ASTM D 624 — Test Method for Tear Strength of Conventional Vulcanized Rubber and Thermoplastic Elastomer.
 5. ASTM D 746 — Test Method for Brittleness Temperature of Plastics by Impact.
 6. ASTM D 792 — Test Method for Specific Gravity (Gravity Density) and Density of Plastics by Displacement.
 7. ASTM D 1171 — Test Method for Ozone Resistance at 500 pphm.

SECTION 03150 — WATERSTOPS FOR CONCRETE JOINTS — rev. 011/29/16

***** MasterFormat™ 2004 — Section 03 15 13 *****

8. ASTM D 2240 — Test Method for Shore Hardness.
 - B. Federal Specifications
 1. COE CEGS-03250 July 1995 Guide Specification for Military Construction.
 2. EPA Title 40 CFR Section 265.193.
 - C. American Concrete Institute
 1. ACI 350.2R-04 — Concrete Structures for Containment of Hazardous Wastes.
 - D. NSF International
 1. NSF/ANSI Standard 61 Certification for Drinking Water System Components — Health Effects.
 - E. Canadian Council of Ministers of the Environment
 1. Environmental Code of Practice for Aboveground and Underground Storage Tank Systems Containing Petroleum and Allied Petroleum Products.
 - F. BuildingGreen, Inc.
 1. GreenSpec® — GreenSpec® Directory, 6th Edition (and later).
3. Submittal Procedures
 - A. Chemical Resistant TPV Waterstop
 1. Earth Shield® TPV Waterstop submittal shall contain the following:
 - a. Samples of each size and shape to be used.
 - b. Plate drawings of the waterstop profile indicating all dimensions.
 - c. Shop drawings of shop made fittings to be provided by the manufacturer or prepared by the contractor.
 - d. Certified chemical resistance per ASTM D 471.
 - e. Copy of independent certification to NSF/ANSI Standard 61 Certification for Drinking Water System Components — Health Effects.
 - f. Copy of independent testing to ASTM D 1171 Ozone Resistance to 500 pphm concentration.
 - g. Manufacturer's Literature, MSDS sheets, installation, safety, and splicing instructions.
 - h. Certificate of compliance to physical properties outlined in this specification with third-party independent test reports (all testing reports within three years of date of submittal).
 2. Chemical Resistant TPV Waterstop and Splices — Specimens identified to indicate manufacturer, type of material, size, quantity of material, and shipment or lot represented. Each sample shall be not less than 6 inches long of each type, size, and lot furnished. One splice sample of each size and type for every 50 splices made in the shop and every 10 splices made at the job site. The splice samples shall be made using straight run pieces with the splice located at the mid-length of the sample and finished as required for the installed waterstop. The total length of each splice shall be not less than 12 inches long.
 4. Delivery and Storage

Material delivered and placed in storage shall be stored off the ground and protected from moisture, dirt, and other contaminants.

PART 2 PRODUCTS

1. Chemical Resistant TPV Waterstop

Intersection and change of direction waterstops shall be factory fabricated.

A. Manufacturer:

JP Specialties, Inc. — Murrieta, CA, USA 92562 — Phone 800-821-3859; 951-763-7077; Fax 951-763-7074; Web www.earthshield.com; E-mail davidp@earthshield.com

- #### B. Chemical Resistant Non-Metallic Waterstops
- Non-metallic waterstops shall be manufactured from a fully cross-linked thermoplastic vulcanizate (TPV), containing no plasticizer, mineral fillers, scrap or reclaimed material.

SECTION 03150 – WATERSTOPS FOR CONCRETE JOINTS – rev. 03/03/18









******* MasterFormat™ 2004 – Section 03 15 13 *******

1. Thermoplastic Vulcanizate (TPV) Waterstop shall conform to EPA Title 40 CFR Section 265.193. The suitability of the waterstop for a specific application should be determined by specific testing for that particular requirement by ASTM D 471.
2. Thermoplastic Vulcanizate (TPV) Waterstop shall be certified for use in potable water per NSF/ANSI Standard 61. Third-party certified documentation to be provided by manufacturer.
3. Thermoplastic Vulcanizate (TPV) Waterstop shall be independently GreenSpec listed. Third-party documentation to be provided by manufacturer.

Thermoplastic Vulcanizate (TPV) Waterstop shall conform to the following typical physical properties:

Property	Test Method	Required Results
Specific Gravity	ASTM D 792	.96
Shore A Hardness (5 sec.)	ASTM D 2240	90±3 at 25°C (77°F)
Tensile Strength	ASTM D 412	2,300 psi
Ultimate Elongation	ASTM D 412	530%
100% Modulus	ASTM D 746	1,000 psi
Tear Strength	ASTM D 624	278 pli at 25°C (77°F)
Compression Set	ASTM D 395	29% at 25°C (77°F)
Brittle Point	ASTM D 746	-61°C (-78°F)
Drinking Water Safe	NSF/ANSI 61 	Certified for use in potable water
Ozone Resistance	ASTM D 1171	Passed, no cracking at 600 pphm
Chemical Resistance	ASTM D 471	Meet or exceed specific testing standards for contained fluids as required by Owner and <i>certified</i> by Manufacturer.
Green Certification	GreenSpec	Approved

Unless otherwise specified or indicated on the drawings provide the following types:

1. **Part No. JP436** – 4" x 3/16" ribbed centerbulb, as manufactured by J P Specialties, Inc. (*all-purpose waterstop; if specified with factory installed brass eyelets use part no. EYJP436*) 
2. **Part No. JP636** – 6" x 3/16" ribbed centerbulb, as manufactured by J P Specialties, Inc. (*all-purpose waterstop; if specified with factory installed brass eyelets use part no. EYJP636*) 
3. **Part No. JP637** – 6" x 3/8" ribbed flat strip, as manufactured by J P Specialties, Inc. (*construction joint waterstop; if specified with factory installed brass eyelets use part no. EYJP636*) 
4. **Part No. JP638** – 6" x 3/8" heavy-duty ribbed centerbulb, as manufactured by J P Specialties, Inc. (*all-purpose waterstop; if specified with factory installed brass eyelets use part no. EYJP638*) 
5. **Part No. JP936** – 9" x 3/16" ribbed centerbulb, as manufactured J P Specialties, Inc. (*all-purpose waterstop; if specified with factory installed brass eyelets use part no. EYJP936*) 
6. **Part No. JP937** – 9" x 3/8" ribbed flat strip, as manufactured by J P Specialties, Inc. (*construction joint waterstop; if specified with factory installed brass eyelets use part no. EYJP636*) 
7. **Part No. JP938** – 9" x 3/8" heavy-duty ribbed centerbulb, as manufactured by J P Specialties, Inc. (*all-purpose waterstop; if specified with factory installed brass eyelets use part no. EYJP938*) 
8. **Part No. JP678** – 6" x 3/16" ribbed tear web, as manufactured by J P Specialties, Inc. (*for extreme joint movement; if specified with factory installed brass eyelets use part no. EYJP678*) 
9. **Part No. JP978** – 9" x 3/16" ribbed tear web, as manufactured by J P Specialties, Inc. (*for extreme joint movement; if specified with factory installed brass eyelets use part no. EYJP978*) 

SECTION 03150 — WATERSTOPS FOR CONCRETE JOINTS — rev. 011/29/16

***** MasterFormat™ 2004 — Section 03 15 13 *****

10. **Part No. JP206** — 6" x 1/8" base seal, as manufactured by J P Specialties, Inc. *(for runway and pavement applications)* NSF
11. **Part No. JP211** — 9" x 3/16" base seal, as manufactured by J P Specialties, Inc. *(for runway and pavement applications)* NSF
12. **Part No. JP215** — Corner seal, as manufactured by J P Specialties, Inc. *(for wall/slab interface)* NSF
13. **Part No. JP320L** — 3" x 3/16" tear web retrofit, as manufactured by J P Specialties, Inc. *(for joining concrete to existing surface; if specified with factory installed brass eyelets use part no. EYJP320L)* NSF
14. **Part No. JP336L** — 3" x 3/16" retrofit, as manufactured by J P Specialties, Inc. *(for joining concrete to existing surface; if specified with factory installed brass eyelets use part no. EYJP336L)* NSF
15. **Part No. JP621L** — 4-1/2" x 3/16" large movement retrofit, as manufactured by J P Specialties, Inc. *(for joining concrete to existing surface; large shear movements)* NSF
16. **Part No. JP325T** — 3" x 3/16" T-shaped retrofit, as manufactured by J P Specialties, Inc. *(for joining concrete to existing surface; if specified with factory installed brass eyelets use part no. EYJP325T)* NSF
17. **Part No. JP450T** — 5" x 3/16" T-shaped retrofit, as manufactured by J P Specialties, Inc. *(for joining concrete to existing surface; if specified with factory installed brass eyelets use part no. EYJP450T)* NSF
18. **Part No. JP500** — 4.5" x 3/16" post-applied flat retrofit, as manufactured by J P Specialties, Inc. *(for post-applied, surface sealing)* NSF
19. **Part No. JP540L** — 4.5" x 3/16" post-applied corner retrofit, as manufactured by J P Specialties, Inc. *(for for post-applied, surface to wall sealing)* NSF
20. **Part No. JP443** — 4" x 3/16" dumbbell, as manufactured by J P Specialties, Inc. *(for construction joints)* NSF
21. **Part No. JP647** — 6" x 1/4" dumbbell, as manufactured by J P Specialties, Inc. *(for construction joints)* NSF
22. **Part No. JP648** — 6" x 3/8" dumbbell, as manufactured by J P Specialties, Inc. *(especially designed for Carollo Engineers [construction joints])* NSF
23. **Part No. JP948** — 9" x 3/8" dumbbell, as manufactured by J P Specialties, Inc. *(for construction joints)* NSF
24. **Part No. JP949** — 9" x 3/8" dumbbell centerbulb, as manufactured by J P Specialties, Inc. *(especially designed for Carollo Engineers [expansion joints])* NSF
25. **Part No. JP1149** — 12" x 3/8" dumbbell centerbulb, as manufactured by J P Specialties, Inc. *(especially designed for Carollo Engineers [expansion joints])* NSF
26. **Part No. JP158** — 1" screed key cap, as manufactured by J P Specialties, Inc. *(designed for keyed joints)* NSF
27. **Part No. JP1225** — 1" integrated screed key cap seal waterstop, as manufactured by J P Specialties, Inc. *(designed for keyed joints; if specified with factory installed brass eyelets use part no. EYJP1225)*
28. **Part No. JPEB350** — 1/2" integrated cap seal waterstop, as manufactured by J P Specialties, Inc. *(designed for expansion joints; if specified with factory installed brass eyelets use part no. EYJPEB350)* NSF
29. **Part No. JPEB375** — 3/4" integrated cap seal waterstop, as manufactured by J P Specialties, Inc. *(designed for expansion joints; if specified with factory installed brass eyelets use part no. EYJPEB375)* NSF

SECTION 03150 — WATERSTOPS FOR CONCRETE JOINTS — rev. 03/03/18

***** MasterFormat™ 2004 — Section 03 15 13 *****

30. **Part No. JPEB375R** — 3/4" integrated cap seal retrofit waterstop, as manufactured by J P Specialties, Inc. (*designed for expansion joints; if specified with factory installed brass eyelets use part no. EYJPEB375R*) 

PART 3 EXECUTION

1. Waterstop, Installations and Splices — Waterstops shall be installed at the locations shown to form a continuous fluid-tight diaphragm. Adequate provision shall be made to support and completely protect the waterstops during the progress of the work. Any waterstop punctured or damaged shall be repaired or replaced. Exposed waterstops shall be protected during application of form release agents to avoid being coated. Suitable guards shall be provided to protect exposed projecting edges and ends of partially embedded waterstops from damage when concrete placement has been discontinued. Splices shall be made by certified, trained personnel using approved equipment and procedures.
 - A. Non-Metallic Shop Made Fittings — Fittings shall be shop made using a machine specifically designed to mechanically weld the waterstop. A miter guide, proper template (profile dependent), and portable power saw shall be used to miter cut the ends to be joined to ensure good alignment and contact between joined surfaces. The splicing of straight lengths shall be done by squaring the ends to be joined and using an ST-10® waterstop splicing tool. Continuity of the characteristic features of the cross section of the waterstop (ribs, tabular center axis, protrusions, etc.) shall be maintained across the splice.
 - B. Thermoplastic Vulcanizate Waterstop — The splicing of straight lengths shall be done by squaring the ends to be joined and using an ST-10® waterstop splicing tool utilizing a thermoplastic splicing iron with a non-stick surface specifically designed for waterstop welding. The correct temperature (410°F to 430°F) shall be used to sufficiently melt without charring the plastic. The spliced area, when cooled, shall show no signs of separation, holes, or other imperfections when bent by hand in as sharp an angle as possible.
2. Preparation
 - A. Uncoil waterstop 24 hours prior to installation for ease of handling and fabrication.
 - B. Position waterstop to ensure proper distance from steel reinforcing bars to prevent rock pockets and honeycomb (see installation section 3.04).
 - C. Protect waterstop from damage during progress of work.
 - D. Clean concrete joint after first pour to remove debris and dirt.
3. Examination/Inspection
 - A. Prior to placement of concrete notify engineer for field inspection approval.
 - B. Inspect waterstop and field splices for defects and conformance to Quality Assurance Standard section 3.05.
 - C. Upon inspection of waterstop installation, replace any damaged or unacceptable waterstop and dispose of defective material.
4. Installation
 - A. Position waterstop in joint as indicated on drawings.
 - B. Center waterstop on joint, with approximately one-half of waterstop width to be embedded in concrete on each side of the joint.
 - C. Allow clearance between waterstop and reinforcing steel of a minimum two times the largest aggregate size. Prevent rock pockets and air voids caused by aggregate bridging.
 - D. Ensure centerbulb is not embedded at expansion joints.
 - E. Secure waterstop in correct position using optional factory-installed brass eyelets (or JPS hog rings crimped between last two ribs on 12 inch maximum centers), and wire tie to adjacent reinforcing steel. Center-to-center spacing may be increased upon written request and approval from ENGINEER.
 - F. Carefully place concrete without displacing waterstop from proper position.

SECTION 03150 — WATERSTOPS FOR CONCRETE JOINTS — rev. 011/29/16

******* MasterFormat™ 2004 — Section 03 15 13 *******

- G. Thoroughly and systematically vibrate concrete in the vicinity of the joint, and to maximized intimate contact between concrete and waterstop.
 - H. After first pour, clean unembedded waterstop leg to ensure full contact of second concrete pour. Remove laitance, spillage, form oil and dirt.
5. Quality Assurance — Edge welding will not be permitted. Centerbulbs shall be compressed or closed when welding to non-centerbulb type. Waterstop splicing defects which are unacceptable include, but are not limited to the following:
- A. Tensile strength not less than 60 percent of parent sections.
 - B. Free lap joints.
 - C. Misalignment of centerbulb, ribs, and end bulbs greater than 1/16 inch.
 - D. Misalignment which reduces waterstop cross section ore than 15 percent.
 - E. Bond failure at joint deeper than 1/16 inch or 15 percent of material thickness.
 - F. Misalignment of waterstop splice resulting in misalignment of waterstop in excess of 1/2 inch in 10 feet.
 - G. Visible porosity in the weld.
 - H. Charred or burnt material.
 - I. Bubbles or inadequate bonding.
 - J. Visible signs of splice separation when cooled splice (24 hours or greater) is bent by hand at sharp angle.

END OF SECTION

All information is presented in good faith and the results are believed to be accurate. All testing was done independently of Earth Shield® and J P Specialties, Inc.; therefore, neither Earth Shield® nor J P Specialties, Inc. makes any guarantee as to the testing data accuracy or the results obtained.

 NSF mark denotes NSF Standard 61 certification.





Waterstop Job Site Installation Guide

551 Birch Street, Lake Elsinore, CA 92530

Phone: (951)-674-6869 • (800) 821-3859 • FAX (951) 674-1315

www.jp-specialties.com • jpsales@jpspecialties.com

NOTE: It is highly recommended that you use a JP Specialties, Inc. ST-10® Waterstop Splicing Machine. The following directions are for welding WITHOUT an ST-10. The ST-10 will greatly enhance the quality of the welds and reduce welding time.

FIELD FABRICATIONS: Following is the proper procedure, as recommended by JP Specialties, Inc. for field splicing nonmetallic waterstops.

1. Provide shop made fabricated waterstop ells, tees, crosses and transitions leaving only straight butt joint splices for the field. **Always cut ends square before welding waterstop. Never weld to extruded end.**
2. Use a work table to create field splices. Table should be solid, have access to 115 volt power supply, and have jigs and fixtures to aid splicing.
3. Cut ends square, using a razor knife or circular saw equipped with a carbide tipped blade (10" diameter with 40 teeth) to ensure matching edges.
4. Preheat Teflon covered splicing iron (JP 214 or JP 414) to 350-380°F for PVC or 410 to 430°F for TPER / TPV. It is recommended that you verify the temperature with a digital thermometer.
5. Place iron between butt ends. Keep waterstop in place until approximately 3/16" bead forms on each side of waterstop. Quickly remove splicing iron and hold waterstop ends together until they bond (approximately 3 to 5 minutes or cool to the touch). Cold water may be sprayed on waterstop to expedite the bond. Do not move, bend, stretch or stress the splice before the recommended bond time. **When welding TPER / TPV, if you do not join the ends quickly, the melted material will skin over, resulting in an inadequate bond.**
6. When fabricating waterstop into horizontal tees, ells or crosses always miter the ends at a 45 degree angle so the continuity of the ribs and/or center bulb are maintained. This will also produce a much stronger joint. JPS Shop Made Fittings are mechanically welded on an XLT 2000 Splicing Table and conform to Corp of Engineers 03250 Installation Guide, July 1995. Shop Made Fittings exceed the specifications and present a cost effective alternative to field fabrications.

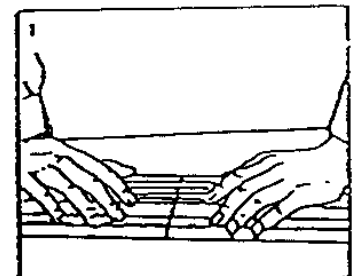
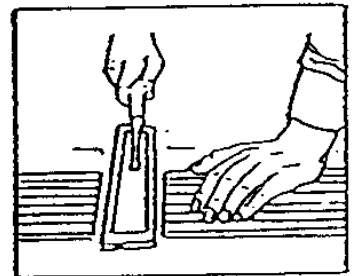
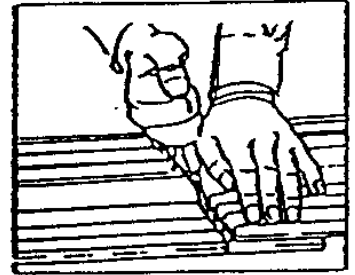

Call JP Specialties, Inc. for more information.

SPECIAL SAFETY NOTATION: When splicing PVC waterstop, inhalation of the fumes may be harmful to your health. Splicing should be done only in areas with adequate ventilation.



revised 04/08



Guia de Instalacion de Waterstop

551 Birch Street, Lake Elsinore, CA 92530
Phone: (951)-674-6869 • (800) 821-3859 • FAX (951) 674-1315
www.jpsspecialties.com • karina@jpsspecialties.com

NOTA: Se recomienda que utilice la maquina que empalma JP Specialties, Inc. ST-10® Waterstop. Las direcciones siguientes son dirigidas sin usar la maquina ST-10. La maquina ST-10 realizara grandemente la calidad de la soldadura y reducira el tiempo usado para soldar.

FABRICACIONES DEL CAMPO: Lo que sigue es el procedimiento apropiado para el campo, segun lo recomendado por JP Specialties, Inc. que empalma waterstops que no contiene metales.

1. Propocionar las anas, las tes, las cruces, y las transiciones fabricadas hechas de los waterstops que dejan solamente los empalmes rectos para el campo. **Siempre corte las orillas cuadrada antes de soldar el waterstop. No se debe soldar con mucha fuerza para no dañar el material.**
2. Utilizar una tabla de trabajo para crear los empalmes del campo. La tabla debe ser solida, tener acceso a la fuente de alimentacion de 115 voltios, y tener plantillas y accesorios para ayudar a empalmar.
3. Cortar los extremos cuadrados, usar un cuchillo o una sierra circular equipada de una lamina inclinada carburo (10" diametro con 40 dientes) para asegurar que los bordes queden parejos.
4. Precalear la plancha, cubierta en Teflon (JP 214 or JP 414), a 350-380°F para el PVC o a 410 to 430°F para TPER / TPV. Se recomienda verificar la temperatura con un termometro digital.
5. Colocar el hierro entre los extremos. Mantener el waterstop en lugar hasta que un bordado de aproximadamente 3/16" se forme en cada lado del waterstop. Quitar rapidamente la plancha que empalma y colocar los extremos del waterstop juntos hasta que enlacen (aproximadamente 3 a 5 minutos o se sienta fresco al tacto). El waterstop se puede rociar con agua fria para apresurar el enlace. No mover, no doblar, no estirar ni tensionar el empalme antes de que el tiempo recomendado enlace. **Al soldar el TPER / TPV, si no se ensamblan los extremos rapidamente, el material derretido pelara encima, dando por resultado un enlace inadecuado.**
6. Al fabricar el waterstop en tes horizontales, las anas o las cruces junten los extremos a un angulo de 45 grados para que se mantenga la continuidad de las costillas y/o el bulbo de centro. Esto producira un empalme mucho mas fuerte. Las medidas fabricadas en el almacan de JPS se sueldan mecanicamente en una tabla XLT 2000 que empalma y se ajusta a medida con las regulaciones de la Guia de la Corp de Ingenieros 03250 Julio 1995. Los ajustes hechos en la fabrica an excidido las especificaciones y presenta una alternativa economicamente razonable para las fabricaciones del campo de trabajo.

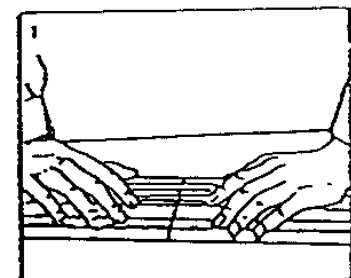
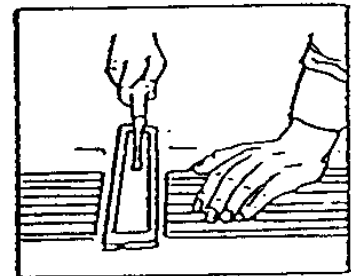
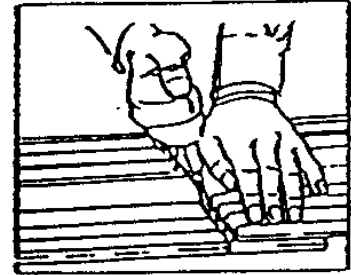

Contactar a JP Specialties, Inc. para mas informacion.

NOTACION ESPECIAL DE CUIDADO: Al empalmar el waterstop del PVC la inhalacion de los humos puede ser danosa a su salud. El empalmar se debe hacer solamente en areas con la ventilacion adecuada.

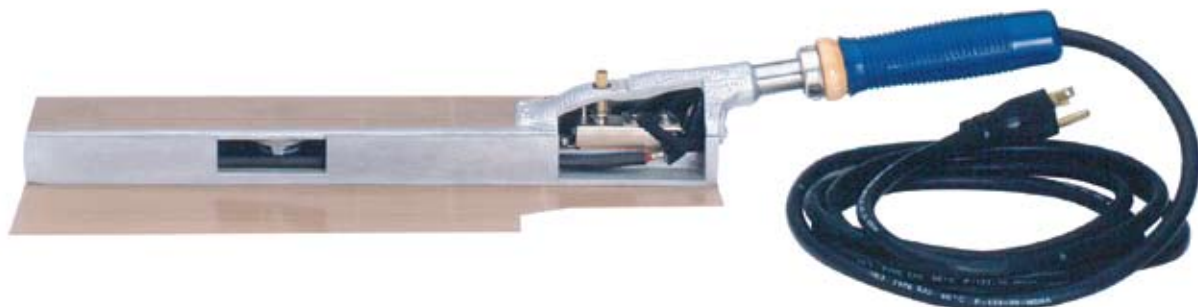

revised 04/08

SECTION 1: Identification of the substance/mixture and of the company/undertaking

- **1.1 Product identifier**
- **Trade name / Product code:** *Earth Shield TPV Waterstop*
- **1.2 Relevant identified uses of the substance or mixture and uses advised against** *No further relevant information available.*
- **1.3 Details of the supplier of the safety data sheet**
- **Manufacturer/Supplier:**
J P Specialties, Inc.
- *25811 Jefferson Avenue*
- *Murrieta, CA 92562*
- **Further information obtainable from:**
Product Safety Department
davidp@earthshield.com
- **1.4 Emergency telephone number:**
800-821-3859
951-763-7077

SECTION 2: Hazards identification

- **2.1 Classification of the substance or mixture**
- **Classification according to Regulation (EC) No 1272/2008**
Aquatic Chronic 3 H412 Harmful to aquatic life with long lasting effects.
- **2.2 Label elements**
- **Labelling according to Regulation (EC) No 1272/2008** *The product is classified and labelled according to the CLP regulation.*
- **Hazard pictograms** *Void*
- **Signal word** *Void*
- **Hazard statements**
H412 Harmful to aquatic life with long lasting effects.
- **Precautionary statements**
P101 If medical advice is needed, have product container or label at hand.
P102 Keep out of reach of children.
P103 Read label before use.
P273 Avoid release to the environment.
P501 Dispose of contents/container in accordance with local/regional/national/international regulations.
- **Additional information:**
Contains Tin dichloride. May produce an allergic reaction.
- **2.3 Other hazards**
- **Results of PBT and vPvB assessment**
- **PBT:** *Not applicable.*
- **vPvB:** *Not applicable.*

SECTION 3: Composition/information on ingredients

- **3.2 Chemical characterization: Solid**
- **Description:**
This is a thermoplastic rubber material.

· **Dangerous components:**

CAS: 52829-07-9 EINECS: 258-207-9	bis(2,2,6,6-tetramethyl-4-piperidyl) sebacate ☠ Eye Dam. 1, H318; ☠ Aquatic Acute 1, H400; Aquatic Chronic 2, H411	≤ 2.5%
CAS: 1314-13-2 EINECS: 215-222-5	zinc oxide ☠ Aquatic Acute 1, H400; Aquatic Chronic 1, H410	≤ 2.5%
CAS: 7772-99-8 EINECS: 231-868-0	Tin dichloride ☠ STOT RE 2, H373; ☠ Met. Corr.1, H290; Skin Corr. 1B, H314; ☠ Aquatic Acute 1, H400; Aquatic Chronic 1, H410; ☠ Acute Tox. 4, H302; Acute Tox. 4, H332; Skin Sens. 1, H317; STOT SE 3, H335	≤ 2.5%

- **Additional information:** *For the wording of the listed hazard phrases refer to section 16.*

SECTION 4: First aid measures

- **4.1 Description of first aid measures**
- **After inhalation:**
Supply fresh air; consult doctor in case of complaints.
Inhalation may cause respiratory tract irritation. For this reason, avoid breathing fumes and vapors of process
- **After skin contact:**
Wash with soap and water.
For hot products; immediately immerse in or flush affected area with large amounts of cold water. Cover with clean cotton sheeting. If further treatment is necessary, get medical attention.
- **After eye contact:** *Rinse opened eye for several minutes under running water. If symptoms persist, consult a doctor.*
- **After swallowing:** *Call for a doctor immediately.*

Trade name / Product code: Earth Shield TPV Waterstop

(Contd. of page 1)

- **4.2 Most important symptoms and effects, both acute and delayed** No further relevant information available.
- **4.3 Indication of any immediate medical attention and special treatment needed** No further relevant information available.

SECTION 5: Firefighting measures

- **5.1 Extinguishing media**
- **Suitable extinguishing agents:**
 - Foam
 - Carbon dioxide
 - Dry Chemicals
- **5.2 Special hazards arising from the substance or mixture**
Thermal decomposition or burning may release CO₂, CO, fume and a variety of products ranging from hydrocarbons to toxic/irritating gases.
- **5.3 Advice for firefighters**
- **Protective equipment:**
 - Wear self-contained respiratory protective device.
 - Wear fully protective suit.
- **Additional information** Collect contaminated fire fighting water separately. It must not enter the sewage system.

SECTION 6: Accidental release measures

- **6.1 Personal precautions, protective equipment and emergency procedures**
Avoid formation of dust.
- **6.2 Environmental precautions:**
Inform respective authorities in case of seepage into water course or sewage system.
Do not allow to enter sewers/ surface or ground water.
- **6.3 Methods and material for containment and cleaning up:**
Dispose contaminated material as waste according to item 13.
Pick up mechanically.
Send for recovery or disposal in suitable receptacles.
- **6.4 Reference to other sections**
See Section 7 for information on safe handling.
See Section 8 for information on personal protection equipment.
See Section 13 for disposal information.

SECTION 7: Handling and storage

- **7.1 Precautions for safe handling**
Ensure good ventilation/exhaustion at the workplace.
Do not eat, drink or smoke in the workplace.
Use good personal hygiene and housekeeping.
Eliminate all ignition sources.
- **Information about fire - and explosion protection:**
Keep ignition sources away - Do not smoke.
Keep respiratory protective device available.
- **7.2 Conditions for safe storage, including any incompatibilities**
- **Storage:**
- **Requirements to be met by storerooms and receptacles:**
Store in cool and dry place
Avoid extremes of temperature and humidity
Excessive weight may induce compaction
- **Information about storage in one common storage facility:** No information
- **Further information about storage conditions:**
Store in cool, dry conditions.
Shelf Life: Indefinite

SECTION 8: Exposure controls/personal protection

- **Additional information about design of technical facilities:** No further data; see item 7.
- **8.1 Control parameters**
- **Ingredients with limit values that require monitoring at the workplace:**
The product does not contain any relevant quantities of materials with critical values that have to be monitored at the workplace.
- **Additional information:** The lists valid during the making were used as basis.
- **8.2 Exposure controls**
- **Personal protective equipment:**
- **General protective and hygienic measures:** The usual precautionary measures are to be adhered to when handling chemicals.

(Contd. on page 3)

Trade name / Product code: Earth Shield TPV Waterstop

(Contd. of page 2)

- **Respiratory protection:**
Provide ventilation to remove any vapours and fumes released during process.
Avoid breathing in process fumes. These can be irritating to eyes and respiratory tract if no ventilation is provided.
- **Protection of hands:**
The glove material has to be impermeable and resistant to the product/ the substance/ the preparation.
Due to missing tests no recommendation to the glove material can be given for the product/ the preparation/ the chemical mixture.
Selection of the glove material on consideration of the penetration times, rates of diffusion and the degradation
- **Material of gloves**
Contact the glove manufacturer for specific advice on glove selection.
Chemical resistant gloves are recommended and if the product is hot, thermally protective, chemical resistant gloves are used.
The selection of the suitable gloves does not only depend on the material, but also on further marks of quality and varies from manufacturer to manufacturer. As the product is a preparation of several substances, the resistance of the glove material can not be calculated in advance and has therefore to be checked prior to the application.
- **Penetration time of glove material** The exact break through time has to be found out by the manufacturer of the protective gloves and has to be observed.
- **Eye protection:** Safety glasses
- **Body protection:** Protective work clothing

SECTION 9: Physical and chemical properties

- **9.1 Information on basic physical and chemical properties**
- **General Information**
- **Appearance:**

Form:	Extruded Profile
Color:	Black
Odor:	Characteristic
- **Change in condition**
Melting point/freezing point: No data available
- **Auto-ignition temperature:** Product is not selfigniting.
- **Explosive properties:** Product does not present an explosion hazard.
- **Density at 20 °C:** 0.96 g/cm³
- **Solubility in / Miscibility with water:** Insoluble.

SECTION 10: Stability and reactivity

- **10.1 Reactivity** see sections below
- **10.2 Chemical stability** Material is stable under normal conditions.
- **10.3 Possibility of hazardous reactions** No dangerous reactions known.
- **10.4 Conditions to avoid** Above 250 °C process not available, decomposition occurs.
- **10.5 Incompatible materials:** Strong oxidisers, halogenated compounds, acetal resin (POM)

SECTION 11: Toxicological information

- **11.1 Information on toxicological effects**
- **Acute toxicity** Based on available data, the classification criteria are not met.

· **LD/LC50 values relevant for classification:**

1314-13-2 zinc oxide

Oral	LD50	> 5000 mg/kg (rat)
------	------	--------------------

- **Primary irritant effect:**
- **Skin corrosion/irritation** Based on available data, the classification criteria are not met.
- **Serious eye damage/irritation** Based on available data, the classification criteria are not met.
- **Respiratory or skin sensitisation** Based on available data, the classification criteria are not met.
- **CMR effects (carcinogenicity, mutagenicity and toxicity for reproduction)**
- **Germ cell mutagenicity** Based on available data, the classification criteria are not met.
- **Carcinogenicity** Based on available data, the classification criteria are not met.
- **Reproductive toxicity** Based on available data, the classification criteria are not met.
- **STOT-single exposure** Based on available data, the classification criteria are not met.
- **STOT-repeated exposure** Based on available data, the classification criteria are not met.
- **Aspiration hazard** Based on available data, the classification criteria are not met.

SECTION 12: Ecological information

- **12.1 Toxicity**
- **Aquatic toxicity:** No further relevant information available.

(Contd. on page 4)

Trade name / Product code: Earth Shield TPV Waterstop

(Contd. of page 3)

- **12.2 Persistence and degradability** No further relevant information available.
- **12.3 Bioaccumulative potential** No further relevant information available.
- **12.4 Mobility in soil** No further relevant information available.
- **Ecotoxicological effects:**
- **Remark:** None
- **Additional ecological information:**
- **General notes:**
None
- **12.5 Results of PBT and vPvB assessment**
- **PBT:** Not applicable.
- **vPvB:** Not applicable.
- **12.6 Other adverse effects** No further relevant information available.

SECTION 13: Disposal considerations

- **13.1 Waste treatment methods**
- **Recommendation** Must not be disposed together with household garbage. Do not allow product to reach sewage system.
- **Uncleaned packaging:**
- **Recommendation:** Disposal must be made according to official regulations.

SECTION 14: Transport information

- Land Transport (ADR-RID)-Not Regulated by J P Specialties, Inc.
- Sea Transport (IMDG)-Not Regulated by J P Specialties, Inc.
- Air Transport (ICAO-IATA)-Not Regulated by J P Specialties, Inc.

SECTION 15: Regulatory information

- **15.1 Safety, health and environmental regulations/legislation specific for the substance or mixture**
- **Directive 2012/18/EU**
- **Named dangerous substances - ANNEX I** None of the ingredients is listed.
- **REGULATION (EC) No 1907/2006 ANNEX XVII** Conditions of restriction: 3
- **15.2 Chemical safety assessment:** A Chemical Safety Assessment has not been carried out.

SECTION 16: Other information

This information is based on our present knowledge. However, this shall not constitute a guarantee for any specific product features and shall not establish a legally valid contractual relationship.

- **Relevant phrases**
H290 May be corrosive to metals.
H302 Harmful if swallowed.
H317 May cause an allergic skin reaction.
H318 Causes serious eye damage.
H335 May cause respiratory irritation.
- **Department issuing SDS:** Product safety and R&D departments
- **Contact:** Mr. David Poole
- **Abbreviations and acronyms:**
GHS: Globally Harmonized System of Classification and Labeling of Chemicals
EINECS: European Inventory of Existing Commercial Chemical Substances
ELINCS: European List of Notified Chemical Substances
CAS: Chemical Abstracts Service (division of the American Chemical Society)
LC50: Lethal concentration, 50 percent
LD50: Lethal dose, 50 percent
PBT: Persistent, Bioaccumulative and Toxic
vPvB: very Persistent and very Bioaccumulative
Met. Corr. 1: Corrosive to metals – Category 1
Acute Tox. 4: Acute toxicity – Category 4
Skin Corr. 1B: Skin corrosion/irritation – Category 1B
Eye Dam. 1: Serious eye damage/eye irritation – Category 1
Skin Sens. 1: Skin sensitization – Category 1
STOT SE 3: Specific target organ toxicity (single exposure) – Category 3
STOT RE 2: Specific target organ toxicity (repeated exposure) – Category 2

(Contd. on page 5)



J.P. SPECIALTIES, INC.

Safety Data Sheet
according to 1907/2006/EC, Article 31

Revision: 05/10/17

Trade name / Product code: Earth Shield TPV Waterstop

(Contd. of page 4)

GB